

DTIC FILE COPY

AD E 501034
Copy 10 of 16 copies

AD-A200 453

IDA MEMORANDUM REPORT M-430

FIGHTER AIRCRAFT DESIGN SYSTEM USER'S MANUAL

Joshua A. Schwartz

September 1988

DTIC
ELECTE
NOV 04 1988
S *cl* H D



INSTITUTE FOR DEFENSE ANALYSES
1801 N. Beauregard Street, Alexandria, Virginia 22311-1772

DISTRIBUTION STATEMENT A

Approved for public release
Distribution Unlimited

88 11 02 021

IDA Log No. HQ 88-331

REPORT DOCUMENTATION PAGE					
1a. REPORT SECURITY CLASSIFICATION Unclassified		1b. RESTRICTIVE MARKINGS			
2a. SECURITY CLASSIFICATION AUTHORITY NA		3. DISTRIBUTION/AVAILABILITY OF REPORT Unclassified and Suitable for Public Release			
2b. DECLASSIFICATION/DOWNGRADING SCHEDULE NA					
4. PERFORMING ORGANIZATION REPORT NUMBER (S) IDA Memorandum Report M-430		5. MONITORING ORGANIZATION REPORT NUMBER (S)			
6a. NAME OF PERFORMING ORGANIZATION Institute for Defense Analyses	6b. OFFICE SYMBOL (if applicable)	7a. NAME OF MONITORING ORGANIZATION			
6c. ADDRESS (City, State, and Zip Code) 1800 N. Beauregard St. Alexandria, VA 22311		7b. ADDRESS (CITY, STATE, AND ZIP CODE)			
8a. NAME OF FUNDING/SPONSORING ORGANIZATION NA	8b. OFFICE SYMBOL (if applicable)	9. PROCUREMENT INSTRUMENT IDENTIFICATION NUMBER IDA Independent Research Program			
8c. ADDRESS (City, State, and Zip Code) NA		10. SOURCE OF FUNDING NUMBERS			
		PROGRAM ELEMENT	PROJECT NO.	TASK NO.	ACCESSION NO. WORK UNIT
11. TITLE (Include Security Classification) Fighter Aircraft Design System User's Manual					
12. PERSONAL AUTHOR (S). Joshua A. Schwartz					
13. TYPE OF REPORT Final	13b. TIME COVERED FROM _____ TO _____	14. DATE OF REPORT (Year, Month, Day) September 1988	15. PAGE COUNT 115		
16. SUPPLEMENTARY NOTATION					
17. COSATI CODES		18. SUBJECT TERMS (Continue on reverse if necessary and identify by block number) Tactical fighter/attack aircraft, Design, Sensitivities, Sizing, Performance, Cost, Lotus 1-2-3 spreadsheets			
FIELD	GROUP				SUB-GROUP
19. ABSTRACT (Continue on reverse if necessary and identify by block number) <p>This Memorandum Report is a User's Manual for a set of four Lotus 1-2-3 spreadsheet models for tactical fixed-wing aircraft design and sensitivities. A sizing model utilizes input requirements such as take-off and landing distances, mission radius, and combat turn rate to determine the wing size, engine thrust, empty weight, and gross weight of the aircraft. Two other models investigate off-design range payload and maneuverability performance. The fourth model estimates the RDT&E, acquisition, and procurement costs.</p>					
20. DISTRIBUTION/AVAILABILITY OF ABSTRACT <input type="checkbox"/> UNCLASSIFIED/UNLIMITED <input checked="" type="checkbox"/> SAME AS RPT <input type="checkbox"/> DTIC USERS		21. ABSTRACT SECURITY CLASSIFICATION UNCLASSIFIED			
22a. NAME OF RESPONSIBLE INDIVIDUAL		22b. TELEPHONE (Include Area Code)	22c. OFFICE SYMBOL		

IDA MEMORANDUM REPORT M-430

FIGHTER AIRCRAFT DESIGN SYSTEM USER'S MANUAL

Joshua A. Schwartz

September 1988



INSTITUTE FOR DEFENSE ANALYSES

IDA Independent Research Program

PREFACE

This document represents the results of a System Evaluation Division Central Research Project to create a model which develops the conceptual designs of fighter and attack aircraft. The review committee consisted of Dr. David Randall, SED Division Director, P. Okamoto, J. Freeh, B. Bontz, J. Shea, J. Graves, and D. Spalding. The author expresses his thanks to this committee as well as to Mr. Ed Parrott and Mrs A. Dew.



The training floppy disk for this report can be obtain from : Institute for Defense Analyses, 1801 Beauregard Street, Alex., Va. 22311 Per Mrs. Betty Pringle, IDA

Accession For	
NTIS GRA&I	<input checked="" type="checkbox"/>
DTIC TAB	<input type="checkbox"/>
Unannounced	<input type="checkbox"/>
Justification	
By	
Distribution/	
Availability Codes	
Dist	Avail and/or Special
A-1	

TABLE OF CONTENTS

GLOSSARY.....	ix
1. INTRODUCTION	1-1
1.1 Purpose of Manual	1-1
1.2 Intended Audience	1-1
1.3 Overview of FADS Models	1-2
A. FADS Inputs	1-2
B. FADS Outputs.....	1-4
C. Limitations of FADS	1-5
1.4 How to Use Manual.....	1-6
1.5 Who Prepared Manual and FADS.....	1-7
2. THE FIGHTER AIRCRAFT DESIGN SYSTEM.....	2-1
2.1 Description of FADS.....	2-1
2.2 What the Models in FADS Do	2-2
A. Fighter Sizing Model (FSM)	2-2
B. Range-Payload Model (RPM).....	2-2
C. Energy/Maneuverability Model (EMM)	2-5
D. Cost Estimation Model (CEM)	2-5
2.3 How to Use FADS.....	2-7
3. FIGHTER SIZING MODEL (FSM).....	3-1
3.1 Purpose.....	3-1
3.2 Architecture	3-1
3.3 Inputs	3-3
A. Tables	3-3
B. Variables	3-4
3.4 Outputs	3-12
4. RANGE-PAYLOAD MODEL (RPM).....	4-1
4.1 Purpose.....	4-1
4.2 Architecture	4-1
4.3 Inputs	4-3

A. Tables	4-3
B. Variables	4-3
4.4 Outputs	4-3
5. ENERGY/MANEUVERABILITY MODEL (EMM).....	5-1
5.1 Purpose.....	5-1
5.2 Architecture	5-1
5.3 Inputs	5-1
A. Tables	5-1
B. Variables	5-3
5.4 Outputs	5-3
6. COST ESTIMATION MODEL (CEM).....	6-1
6.1 Purpose.....	6-1
6.2 Architecture	6-1
6.3 Inputs	6-1
6.4 Outputs	6-1
7. SUPPLEMENTAL FADS INFORMATION	7-1
7.1 Input Aids	7-1
7.2 FADS Assumptions.....	7-22
7.3 Improvements for FADS	7-23
8. OVERVIEW OF COMBAT AIRCRAFT DESIGN.....	8-1
8.1 Introduction	8-1
8.2 Phases of Design	8-3
8.3 Classification of Combat Aircraft.....	8-10
8.4 Summary	8-10
APPENDIX A. FADS Comparison With Existing Aircraft	A-1
APPENDIX B. Equations and Methodology Used in FADS	B-1
APPENDIX C. List of Available Macros.....	C-1

LIST OF FIGURES

1.1	Generic Mission Profile.....	1-3
2.1	Fighter Sizing Model Flow Chart.....	2-3
2.2	Range-Payload Model Flow Chart	2-4
2.3	Energy/Maneuverability Model Flow Chart	2-6
2.4	Cost Estimation Model Flow Chart.....	2-8
3.1	Fighter Sizing Model Architecture.....	3-2
4.1	Typical Range-Payload Curve	4-1
4.2	Range-Payload Model Architecture.....	4-2
5.1	Energy/Maneuverability Model Architecture	5-2
6.1	Cost Estimation Model Architecture.....	6-2
7.1	Incremental Drag for External Stores.....	7-10
7.2	Equivalent Airspeed and Mach Number Versus True Airspeed and Altitude for Standard Atmosphere	7-11
7.3	Turn Conversion Chart	7-12
7.4	Approximate Weight Savings from Composite Development Programs.....	7-13
7.5	Wing Planform Parameters.....	7-14
7.6	Wing Section Parameters	7-15
7.7	Wing Thickness Versus Maximum Mach Number of Various Aircraft	7-15
7.8	Aspect Ratio Versus SWEEP for Various Current Aircraft.....	7-16
7.9	Typical Non-Dimensionalized Vertical/Horizontal Stabilizer, Wing-Body Aerodynamic Center, and Center of Gravity Locations.....	7-17
7.10	Drag Characteristics for Bodies of Revolution (Fuselage).....	7-18
7.11	Sample Incremental Drag for Miscellaneous Items	7-19
7.12	Influence of Aerodynamic Interference	7-20

7.13	Thrust and SFC Trends with Airspeed and Altitude.....	7-21
8.1	Engine Thrust Versus Thrust Specific Fuel Consumption.....	8-2
8.2	Sample Mission Profiles.....	8-4
8.3	Hierarchy of Parameters.....	8-5
8.4	Process of Aircraft Design.....	8-6
8.5	The Three Phases or Levels of Aircraft Design.....	8-8
8.6	The Baseline Method for Trade Studies.....	8-9
8.7	MIL-F-8785B Aircraft Classification Specification.....	8-11
8.8	Empty Weight Fraction for Current Aircraft.....	8-12
8.9	Thrust Loading Versus Wing Loading for Current Aircraft.....	8-13

LIST OF TABLES

7.1	Selected Aircraft Characteristics.....	7-2
7.2	Rolling/braking Coefficient of Friction Values.....	7-8
7.3	Approximate Armor Density for Various Materials and Ballistic Protection Levels.....	7-8
7.4	Vertical Stabilizer Volume Coefficient (VSVC) Values for Various Fighter Aircraft.....	7-9
7.5	Typical Values of Surface Roughness (ESR).....	7-9
8.1	Take-Off Wing Loading and Thrust to Weight Trends.....	8-13

GLOSSARY

a	Sonic Velocity
AC	Aircraft Configuration
ABX	Additional Thrust Factor
AR	Wing Aspect Ratio
ARMDEN	Armor Density
ARMNT	Armament Weight
AVL	Available
AVNCS	Avionics Weight
B	Brake
C	Cockpit
CB	Combat
CD, C_D	Drag Coefficient
CEM	Cost Estimation Model
CER	Cost Estimating Relationship
CG	Center of Gravity
CL, C_L	Climb, Coefficient of Lift
CM, C_m	Moment Coefficient
CNTRL	Control
CR	Cruise
DCPR	Defense Contractor Planning Report
DELTE	Delta Specific Energy
DELTV	Delta Velocity
DF	Delta F (CD divided by Q)
DS	Dash
EMM	Energy/Maneuverability Model
ENG	Engine
ESR	Equivalent Sand Roughness
F	Flap, Fuselage
FADS	Fighter Aircraft Design System
FC	Flight Control
FCF	Fuel Calculation Factor
FD	Fuselage Diameter
FL	Fuselage Length
fps	Feet per Second
FRF	Fuel Reserve Factor
FS	Fuel System
FSM	Fighter Sizing Model
FSWS	Flap Span to Wing Span Ratio

FWAF	Fuselage Wetted Area Factor
h, H, ALT	Altitude
HS	Horizontal Stabilizer
HSOD	HS Offset Distance (Vertical)
INTERF	Interference Factor
IOC	Initial Operating Capability
Kts	Knots
Lamda, λ	Wing Taper Ratio
LD	Landing
LER	Leading Edge Radius
LES	Leading Edge Sharpness
LG	Landing Gear
LRMS	Lapse Rate Mach Slope
LT	Loiter
Max, MAX	Maximum Condition
MINCB	Minimum Combat Condition
MISC DRAG	Miscellaneous Flat Plate Drag
Min, MIN	Minimum Condition
MN, M	Mach Number
MP	Mission Profile
MPH	Miles per Hour
MSN	Mission
MTF	Material Technology Factor
MU	Coefficient of Friction
N	Load Factor
NCG/FL	Nose to CG distance divided by FL
NCR	Number of Crew
NF	No Flap (Wing)
NHS/FL	Nose to HS distance divided by FL
NL	Limit Load Factor
NP	Number of Passes
NS	Sustained Load Factor
NVS/FL	Nose to VS distance divided by FL
NWB/FL	Nose to WB distance divided by FL
OWE(R)	Operating Weight Empty (required)
Π , PI	PI; 3.1416
PL	Payload
PROP	Propulsion
PS	Specific Power
Q, q	Dynamic Pressure
R	Roll

REQ	Required
RDTE	Research, Development, Test and Evaluation
RPM	Range-Payload Model
RPV	Remotely Piloted Vehicle
S	Slat
SFC(T)	Specific Fuel Consumption (Table)
SM	Static Margin
SSWS	Slat Span to Wing Span Ratio
SW, S_w	Wing Area
SWEEP, $\Delta c/4$	Wing Sweep
SYS	Systems
T	Thrust, Time
T-C, t/c	Wing Thickness Ratio
T/W	Thrust Loading
TO	Takeoff
TOGW(R)	Take Off Gross Weight (required)
TR	Turn Rate
TRF	Thrust Reversal Factor
UAV	Unmanned Aerial Vehicle
V	Velocity
VS	Vertical Stabilizer
VSAR	VS Aspect Ratio
VSVC	VS Volume Coefficient
W	Wing
W# W#	Phase Fuel Fraction
W/S	Wing Loading
WB	Wing-Body
x, X	Distance

1. INTRODUCTION

1.1 Purpose of This Manual

This manual describes the Fighter Aircraft Design System (FADS). FADS is a set of four Lotus 1-2-3 spreadsheet models used to rapidly estimate the design and sensitivities of fighter-type (tactical) aircraft. The four models are:

- Fighter Sizing Model (FSM)
- Range-Payload Model (RPM)
- Energy/Maneuverability Model (EMM)
- Cost Estimation Model (CEM).

The goal of FADS is to enable the user to examine fighter-type aircraft on both an individual design and a parametric basis. The intent of this manual is not to teach the design and aerodynamics of aircraft, but rather to be a guide to help the user understand and utilize FADS.

1.2 Intended Audience

This manual is written for analysts who require conceptual aircraft designs and sensitivities for use in their analyses. The FADS user should minimally have a basic understanding of aircraft operation and flight mechanics. However, a degree in aeronautical engineering is highly desirable since a familiarity with the concepts and methods used in that discipline will assist the user in generating more realistic, accurate and optimum designs. Therefore, it is recommended that the user consult the sources listed in the reference section for a deeper understanding of the material in this manual.

This manual assumes a proficiency with Lotus 1-2-3 and of an IBM PC or an IBM compatible computer. Any details regarding operation of the PC and Lotus 1-2-3 that are not covered in this manual will be found in the relevant user manuals.

1.3 Overview of FADS Models

A. FADS Inputs

There are two types of inputs to FADS: tables and variables. The amount of input data required varies with each model. FSM needs the largest amount, while CEM uses the fewest.

For FSM, RPM, and EMM a table of atmospheric data--density, sonic velocity, and kinematic viscosity vs. altitude--is required. The standard atmosphere is already incorporated, so unless it is necessary to use values other than those, this data does not need to be entered.

For FSM and RPM, tables of engine specific fuel consumption (SFC) data (fuel flow divided by thrust required) for a range of mach numbers and thrust levels at a specified number of altitudes is required. SFC data for up to 4 altitudes can be input. The values in the tables are fixed performance data for specific engine types.

The variable inputs for the four models that comprise FADS fall under four distinct categories:

- Control (CNTRL)
- Mission Profile (MP)
- Aircraft Configuration (AC)
- Propulsion (PROP).

The Control inputs establish the execution procedure of the program and/or set the bounds of the analysis. Example control inputs are: whether to have a canard or a conventional horizontal tail, whether to calculate or input thrust loading (engine thrust divided by aircraft weight) and wing loading (aircraft weight divided by wing area), and the velocity range to study in EMM.

The models in FADS use a generic mission profile shown in Figure 1.1. The Mission Profile inputs consist of values for various parameters that characterize the legs or phases of this mission. These inputs include the flight altitude, Mach number, payload, and other pertinent data for the specific mission legs.

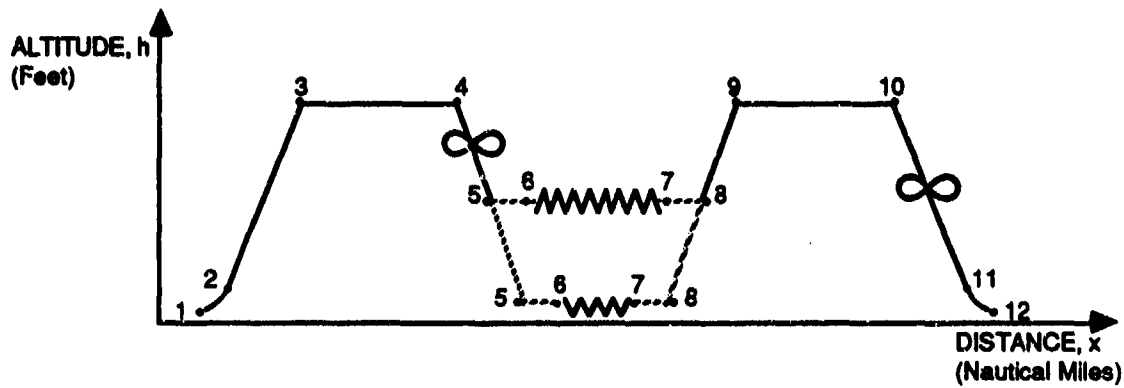

LEG	DESCRIPTION	PHASE NAME
1-2	Engine Start & Takeoff	TO
2-3	Climb to cruise	CL1
3-4	Cruise condition	CR1
4-5	Loiter condition	LT1
5-6	High speed dash	DS1
6-7	Combat condition	CB
7-8	High speed dash	DS2
8-9	Climb to cruise	CL2
9-10	Cruise condition	CR2
10-11	Loiter condition	LT2
11-12	Landing	LD

Note: Climbs and descents are accounted for within the models.

Figure 1.1. Generic Mission Profile

The Aircraft Configuration inputs are organized into three sets of related information. These sets of information along with example inputs are:

- Dimensional Information--wing planform, wing section, fuselage length and diameter
- Weight Information--avionics weight, armament weight, armor weight
- Aerodynamics Information--aircraft surface roughness, miscellaneous drag.

The final type of input to FADS consists of Propulsion data. This data includes:

- Engine thrust lapse rates (slope of thrust versus Mach number) at a specified number of altitudes
- Engine thrust degradation rates (thrust lost) as a function of altitude
- Other specific engine characteristics such as the thrust to weight ratio and the thrust reversing capability.

It is important to note that while all the inputs to FSM can be changed, some of the inputs to EMM, RPM, and CEM are from FSM results and therefore not arbitrary. Thus, FSM must be used first unless all the inputs to the other models are previously known.

B. FADS Outputs

While the types of inputs to the models are essentially the same, each model utilizes varying amounts of them and derives different types of results.

Fighter Sizing Model

FSM generates the following major sizing characteristics of the aircraft:

- Operating Weight Empty (OWE)
- Take-off Gross Weight (TOGW)
- Wing Area (SW), Wing Loading (W/S)
- Thrust Required (T), Thrust Loading (T/W).

In the process, many other important parameters including the take-off and landing distances, horizontal stabilizer area, and mission fuel required are determined.

Range-Payload Model

This model investigates the range-payload performance of the aircraft sized in FSM. The principle outputs of this model are the cruise and mission radii. Many mission profile tradeoffs can be accomplished independently with this model. These include:

- Dash Radius versus Mission Radius
- Loiter Time versus Mission Radius
- Payload versus Mission Radius.

Energy/Maneuverability Model

EMM examines the energy/maneuverability performance traits of the resulting fighter aircraft design. Examples of these traits include sustained turn rate, instantaneous turn rate, and specific power (P_s) levels. The model determines the values of these traits over a specified velocity range and altitude which can be presented graphically. Typical selected graphs include:

- Turn Rate versus Combat Velocity
- Specific Power versus Turn Rate
- Specific Power versus Altitude.

By comparing these plots for different aircraft, an assessment can be made regarding the relative merits of the aircraft design. By including the mission requirements in the comparison, the superiority of one design over another may be ascertained.

Many important velocities, such as the maximum and minimum at the specified altitude, are also estimated by this model. By analyzing additional altitudes, the aircraft flight envelope can be determined.

Cost Estimation Model

CEM uses cost estimating relationships (CERs) developed from current tactical aircraft to derive approximate aircraft Research Development Test and Evaluation (RDTE), Flyaway, and Procurement costs.

C. Limitations of FADS

The assumptions made in the FADS models introduce a number of inherent limitations. A complete list of the technical assumptions is located in section 7.2. Section 7.3 summarizes some of the improvements that could be done to eliminate some of these

limitations. However, there are a few basic assumptions that FADS employs that are essential to understand for proper use of the models. These are discussed in this section.

Conceptual Design Tool

FADS is a tool to be used in the conceptual phase of the design process. The phases of design section in Chapter 8 elaborates on the tasks required in the preliminary and detailed design phases that FADS can not perform. In addition, there are a number of conceptual phase aircraft characteristics that FADS does not consider or generate. For example, it would be very helpful to have a "stealth index" where tradeoffs could be done by varying the "stealthiness" of the design.

Fighter-type Aircraft

As the name implies, FADS is designed to be used for fighter-type aircraft with fuselage mounted engine(s) and inlet(s). The calculation of the empty weight in the sizing model is an example of this restriction. Other areas in the models critically depend on this assumption. A further restriction is that the range of applicable gross weight is from 5,000 to 50,000 pounds.

Generic Mission Profile

The mission data must be derived from the generic profile described previously in Figure 1.1. Inputs are made for each leg of this generic mission profile. It is possible to alter this profile and eliminate undesirable legs by setting either the time or the distance variable value of that leg to zero. While many variations of the mission profile are then possible, this specification is still restrictive.

Subsonic Velocities

Unfortunately, FADS does not incorporate supersonic aerodynamics. It is necessary to limit the Phase Mach numbers in the mission input profile to be less than one. However, the transonic drag rise is accounted for. A number of test equations for determining the supersonic drag were included to assist in an eventual upgrade of the models for this capability. These equations are not currently used.

1.4 How to Use the Manual

The manual is divided up into eight chapters and three appendices. Many of the chapters are recommended reading for the first-time user and are references for the experienced user. The layout of the manual is organized in such a way that users with different levels of experience with FADS need only refer to pertinent sections of it.

First-time users should understand the introductory general FADS material in Chapter 2 before running any of the models. Chapters 3, 4, 5, and 6 contain detailed specific information for each FADS model. The Chapter corresponding to a particular model should be read before using it.

The supplementary FADS information in Chapter 7 is included as a reference for experienced users. Useful data is listed in the input aids section, while the other sections list detailed assumptions used and discuss possible improvements to FADS. Chapter 8 contains an overview of combat aircraft design and is suggested background reading for all interested users.

Appendix A contains a comparison of FADS with existing aircraft--an A-4 and an A-7. Appendix B contains the methodology and equations used in the four spreadsheet models. Appendix C is a list of the available macros for use in FADS.

1.5 Who Prepared FADS and the Manual

The Fighter Aircraft Design System and the User Manual were developed by Joshua A. Schwartz, System Evaluation Division, IDA. The format of FADS is based on a model developed by Ed Parrott of Lockheed-Georgia.

Any questions or comments should be directed to the author at the following address:

Institute for Defense Analyses
1801 North Beauregard Street
Room 229W
Alexandria, Virginia 22311
(703)845-2505

2. THE FIGHTER AIRCRAFT DESIGN SYSTEM

2.1 Description of FADS

FADS is a collection of four related spreadsheet models that are designed to be used in the conceptual phase of the fighter aircraft design process. The models that comprise FADS are:

- **Fighter Sizing Model (FSM)**
- **Range-Payload Model (RPM)**
- **Energy/Maneuverability Model (EMM)**
- **Cost Estimation Model (CEM).**

While all the models investigate important aircraft characteristics, the sizing model is the primary component of FADS and normally used first. The other models are then used because they require data for a sized aircraft (that FSM produces) to operate. By returning to FSM, other sized aircraft can be generated for comparison. Thus, the set of models that comprise FADS are used repetitively to yield an aircraft design. It is only through this iterative process, delineated in Chapter 8, that an optimum design is achieved. Note that since all of the models are used for conceptual design of fighter aircraft, FADS does not yield the definitive aircraft design.

In a sense, the models in FADS are large "number crunchers" that relieve the burden of repetitive hand calculations and thus permit the user to investigate many possible aircraft alternatives. FADS accommodates this by being a flexible tool. The Fighter Sizing Model (FSM) in particular can be used with different constraints. The control (CNTRL) inputs determine which constraints are used.

The modular structure of FADS permits the user to examine different aspects of the design under consideration. Each model is a separate Lotus 1-2-3 spreadsheet and operates independently. However, there are macros in RPM and EMM that transfer data from the sizing model. Macros are saved tasks automated and executed by Lotus by invoking a certain command. These and other macros aid in the process of using the models.

2.2 What the Models In FADS Do

A. Fighter Sizing Model (FSM)

FSM can be run in a number of ways, depending on the control (CNTRL) inputs. By running the model without any calculation control inputs (W/S, Sw, T/W, T) the wing size, thrust required, and empty and gross weights are determined. In this mode of operation the program uses the mission profile, the required combat turn rate, and the take-off and landing distances for the aircraft sizing. If control inputs are used, the model overrides this procedure and uses the inputted constraints. In this second mode the specified performance may not be attained and the output will indicate if this occurs. The flowchart in Figure 2.1 depicts the generalized procedure used in the Fighter Sizing Model. There are two parts to the input data--tables and variables. FSM requires two types of input tables--the atmosphere characteristics and the engine specific fuel consumption and utilizes four types of input variables:

- Control (CNTRL)
- Mission Profile (MP)
- Aircraft Configuration (AC)
- Propulsion (PROP).

With this information, the model iterates until it converges on the design point. The design point is that point at which the aircraft gross weight changes by less than 0.5 pound with another iteration. The sizing model generates two separate outputs:

- Detail Output --lists all calculated variables in the order obtained
- Summary Output --lists inputs and outputs of primary interest.

In addition, the model tabulates those FSM input and output variable values that are required for RPM and EMM. This data can be transferred to the two off-design models to analyze the sized aircraft obtained in FSM.

B. Range-Payload Model (RPM)

This model examines the range-payload performance of a sized fighter aircraft. The generalized procedure used in the range-payload model is shown in Figure 2.2.

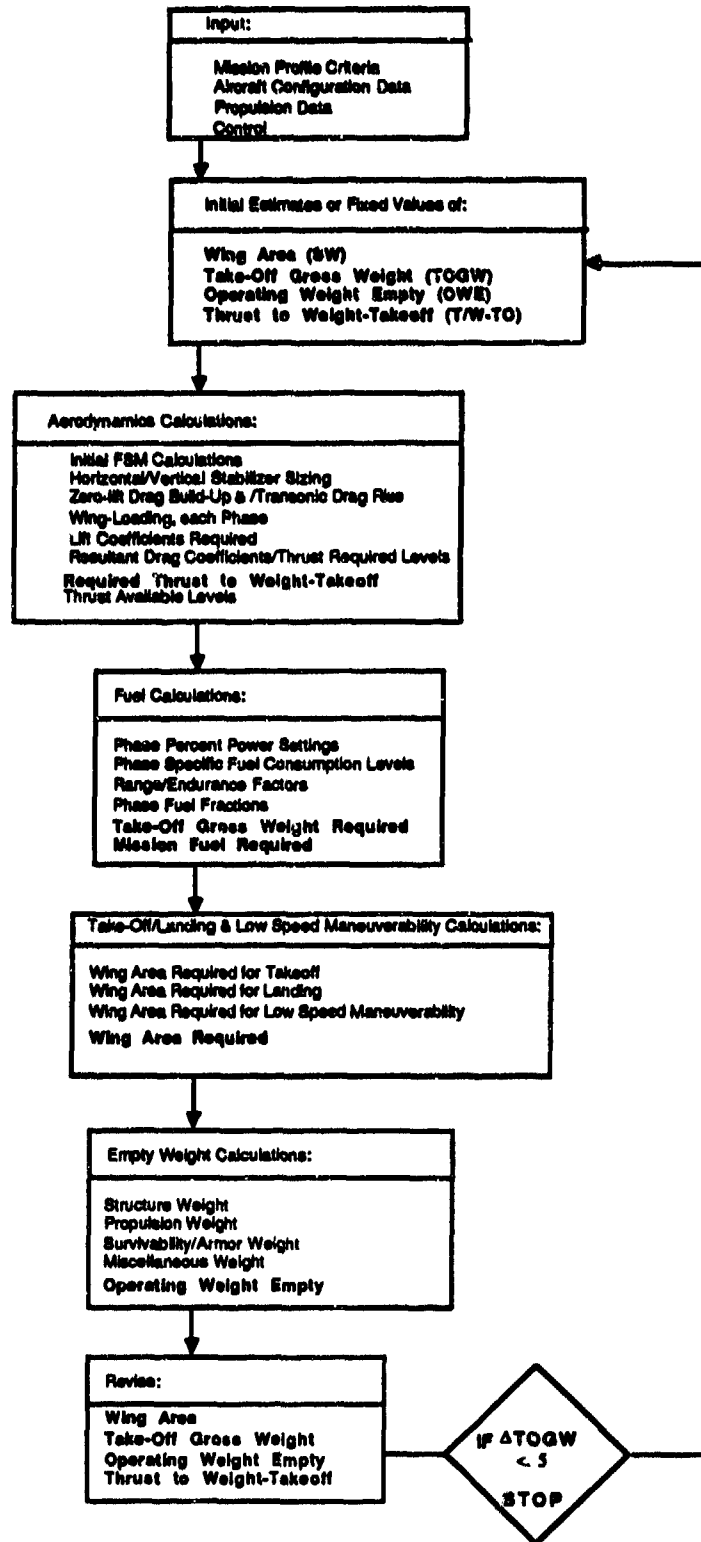

Figure 2.1. Fighter Sizing Model Flow Chart

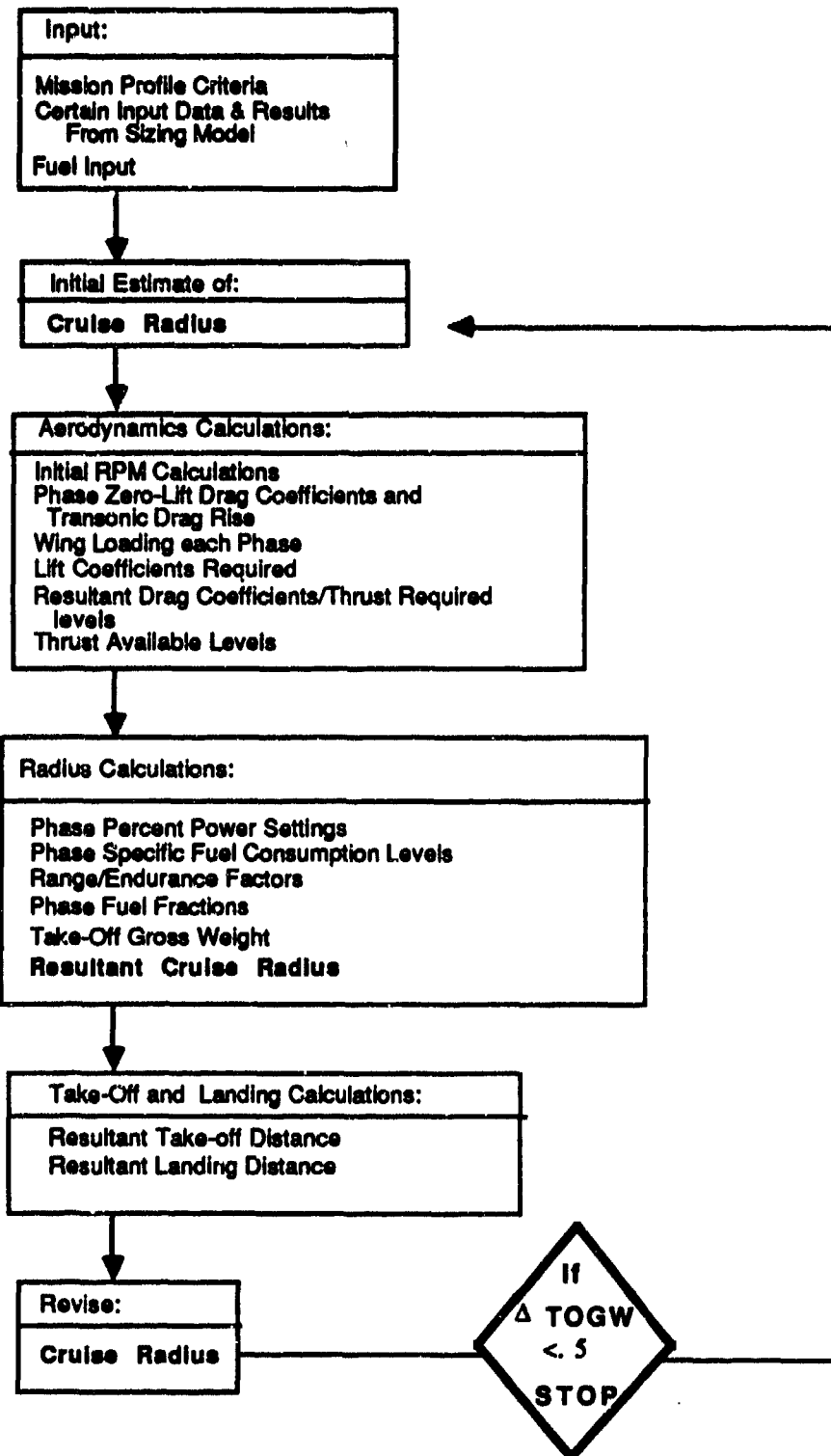

Figure 2.2. Range-Payload Model Flow Chart

As with the sizing model, there are two parts to the input data--tables and variables. Similarly, in this model two types of input tables are necessary--the atmosphere characteristics and the engine specific fuel consumption.

The variables in this model are all of the mission profile (MP) type except for the one new required input--fuel. There are no control inputs to this model. The tables and remaining inputs are taken from the sizing model and are fixed. This model assumes a sized aircraft is obtained from the Fighter Sizing Model.

The Range-Payload Model also uses the aircraft gross take-off weight as the coverage parameter in the iteration process. As in FSM, a detail output and a summary output are provided.

The primary result from this model is the mission radius. This is calculated by determining the maximum possible cruise range. The model also calculates the take-off, landing, and combat turning performance of the aircraft.

C. Energy/Maneuverability Model (EMM)

The Energy/Maneuverability Model analyzes the combat performance of the sized fighter aircraft from FSM. The generalized flow chart for the Energy/Maneuverability Model is shown in Figure 2.3. In this model there are also two parts to the input data: tables and variables. However, in this model only one type of input table is necessary--the atmosphere characteristics. For an analysis using a standard atmosphere, the table is included and does not need to be input. The variables in the Energy/Maneuverability model also consist of fixed inputs and results from the Fighter Sizing Model as well as appropriate control inputs.

This model yields a table that contains various parameters for a specified range of combat velocities. These parameters include sustained and instantaneous turn rates, sustained and instantaneous turn radii, and specific power levels (Ps). In addition, an estimate of important speeds, such as maximum and minimum at the input altitude, are included. The maximum aircraft velocity at best altitude is a required input for CEM.

D. Cost Estimation Model (CEM)

The Cost Estimation Model uses relationships developed from current tactical combat aircraft to derive approximate aircraft Research Development, Test and Evaluation (RDTE), Flyaway, and procurement costs. As shown in Figure 2-4, these relationships are a function of the IOC, maximum thrust, and velocity and the Defense Contractors

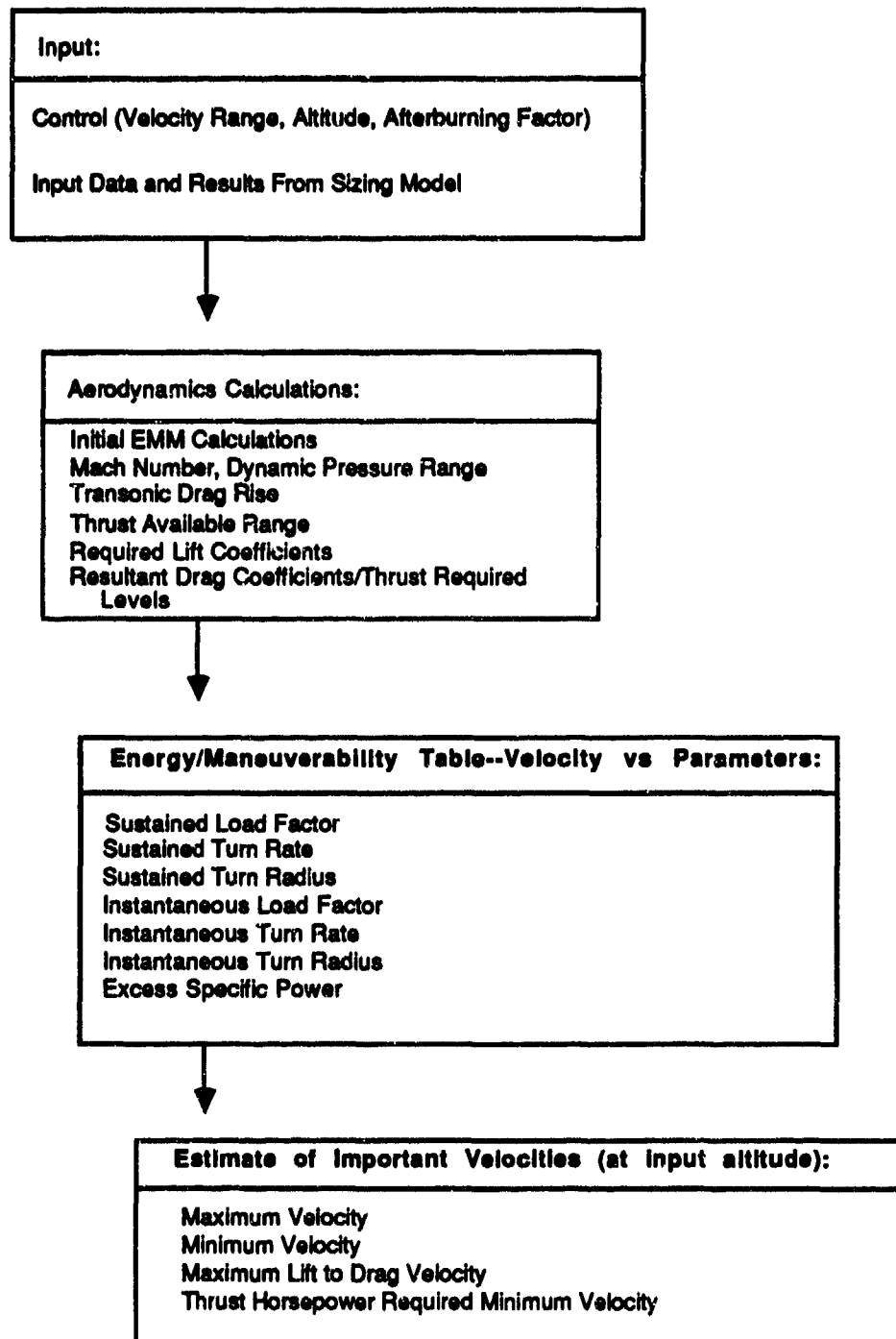

Figure 2.3. Energy/Maneuverability Model Flow Chart

Planning Report (DCPR) Weight. The model determines the DCPR weight, which is also known as the Aeronautical Manufacturers Planning Report (AMPR) Weight, from the operating empty weight.

2.3 How to Use FADS

Since FADS is a compilation of Lotus 1-2-3 spreadsheet models, it is necessary to have the Lotus 1-2-3 software and a personal computer capable of running it. To obtain the models you copy them from the master disk and place them in an appropriate file directory. To use the models, you retrieve the desired file from your directory using the /FileRetrieve command.

Given the number of variables intrinsic to the four models, it is clear that a large number of different aircraft configurations can be analyzed. Therefore, many types of trade-off studies may be accomplished with FADS. It is up to the user, based on their needs, to determine the goal of the study, and to synthesize the best method to accomplish it. This manual can only offer guidelines for these analyses and it will only outline the appropriate operational procedures for FADS.

The four models that comprise FADS use similar spreadsheet formats. At the top of each, a label lists the model name as well as the run name and number. This cell is used to designate the different aircraft under study. A list of the user modifiable input tables follows. Other tables used by FADS, such as the transonic wing drag table, are imbedded into the program and cannot be changed. For each table the name, the location in the spreadsheet, and a short description are included.

In each model the variable inputs are then presented. Variables are labeled in the same format for ease of use. An example is shown below:

Type	Description	Name	Value
MP	velocity-DS1 (kts.)	V-DS1	500

The MP (Mission Profile) signifies what type of variable it is. The description gives a short synopsis of what the variable is and units used. V-DS1 is the variable name used in the formulas in the model. Finally, the 500 is the value used for calculation purposes. Note that throughout FADS the units used for the inputs and outputs are standard English.

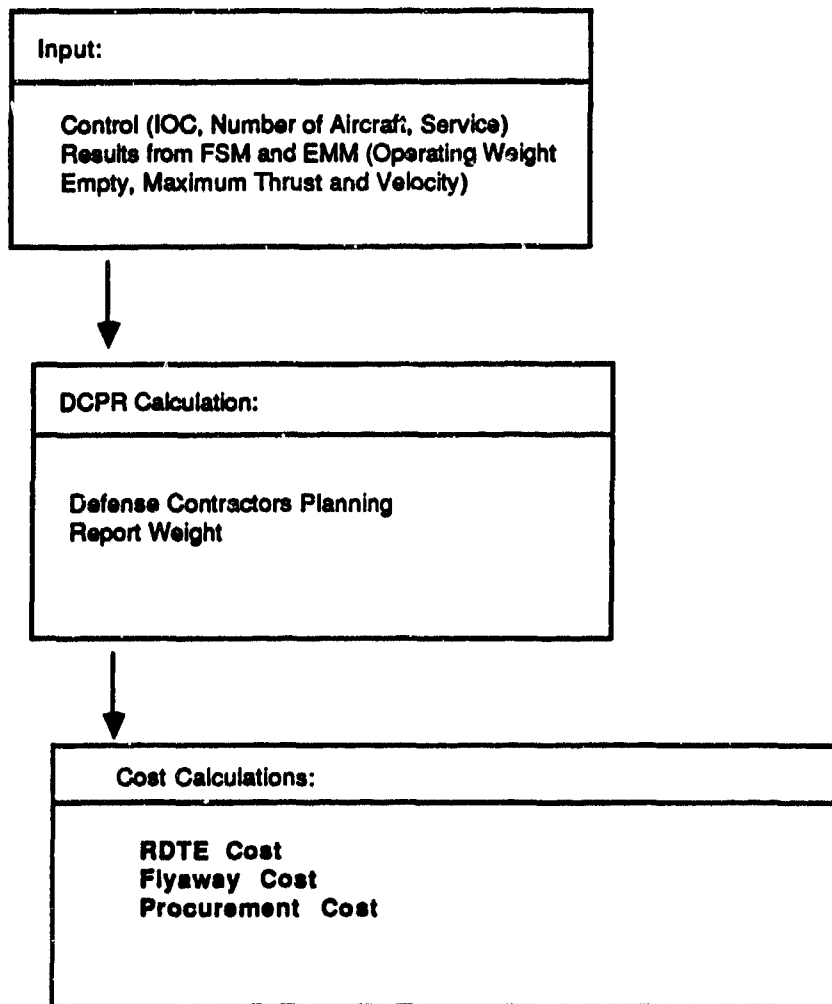

Figure 2-4. Cost Estimation Model Flow Chart

To operate the models, the user inputs selected numbers for the variables in the value column and fills in the appropriate input tables. Once satisfied with the inputs, the user initiates the run macro with the following command: **ALT R**--alt key then the **R** key. This places the user in the summary output of the model. Several tones follow. The low pitched tones signify an iteration, while the high pitched, 4-tone progression indicates convergence and thus a completion of the program. To stop the program before convergence, press: **CTRL Break**. Note that the Energy/Maneuverability Model and the Cost Estimation Model do not require any iteration.

To get a printout of either the input or the output (summary or detail) the user must initiate the print macro with the following command: **ALT P**--alt key then the **P** key. This activates the print menu which allows the selection of the desired printout. The menu contains sufficient explanation of the choices to enable easy use.

The two off-design models, RPM and EMM, have additional macros that automatically transfer the necessary data from FSM. To invoke the data transfer, the following command is entered from EMM or RPM: **ALT T**--alt key then the **T** key. When the data transfer is completed, 2 tones sound.

Chapters 3-6 contain more detailed information regarding the operation of the specific models. The architecture of each spreadsheet model as well as a description of the specific variables and tables are included in their respective chapters.

3. FIGHTER SIZING MODEL (FSM)

3.1 Purpose

The purpose of the Fighter Sizing model is to determine the following aircraft sizing parameters:

- Take-off Gross Weight
- Operating Weight Empty
- Wing Area, Wing Loading at Takeoff
- Thrust, Thrust Loading at Takeoff

The latter two parameters can also be inputs using the proper CNTRL variables. From these outputs, various other factors are established. However, the most important outputs are the Take-off Gross Weight and the Operating Empty Weight. In FADS, these parameters are always outputs.

3.2 Architecture

The Fighter Sizing Model consists of many different parts, as shown by the spreadsheet architecture displayed in Figure 3.1. While the depiction of the spreadsheet in this figure is not to scale, the relative locations of the various parts of the model are shown. The spreadsheet "Home", or cell location A1, is at the upper left hand corner of the header. This is the default location for the cell pointer (rectangular highlight) when the model is retrieved.

When running the model, the spreadsheet iterates in a rowwise (top-down) procedure. Also, the recalculation is manual so the CALC indicator appears in the lower right corner of the screen. If it is desirable to recalculate one iteration at a time, the CALC (F9) function key rather than ALT R must be used.

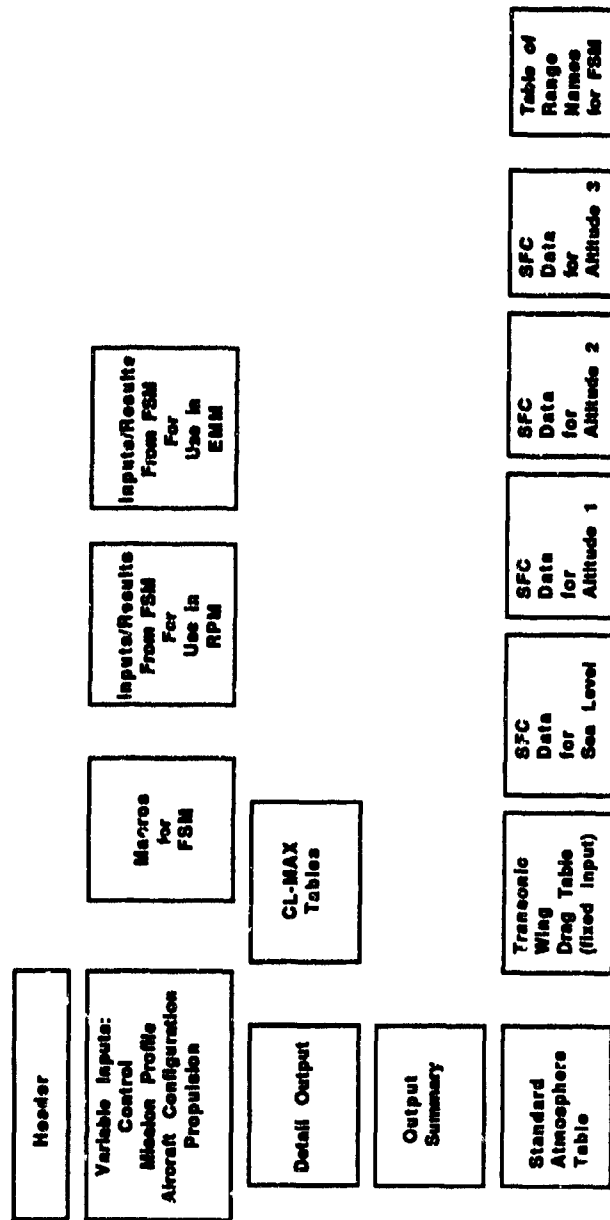

Figure 3.1. Fighter Sizing Model Architecture

3.3 Inputs

A. Tables

There are two types of input tables required for the operation of FSM--the atmosphere characteristics and the engine specific fuel consumption.

Atmosphere Characteristics

The atmosphere characteristics table contains the necessary atmospheric data--density, sonic velocity, and kinematic viscosity from 0 (sea level) to 60,000 feet. The standard atmosphere table (SAT) is already entered, so this table need not be altered.

Specific Fuel Consumption Table (SFCT)

The second type of table is the engine specific fuel consumption. Fuselage mounted engine data are required to input the specific fuel consumption--fuel used per hour per pound of thrust--for specified engine power settings at discrete Mach numbers. These data are a function of the type of engine (Propfan, Turbofan, Turbojet) and the technology level that is being considered. The format used in these tables is shown below.

SEA LEVEL--SPECIFIC FUEL CONSUMPTION TABLE						
MACH #		POWER		SETTING		
		0.2	0.4	0.6	0.8	1
0	0	1	2	3	4	5
0.1	1	0.225	0.155	0.145	0.14	0.14
0.2	2	0.45	0.305	0.29	0.28	0.28
0.3	3	0.52	0.39	0.35	0.34	0.33
0.4	4	0.6	0.47	0.415	0.39	0.38
0.5	5	0.76	0.585	0.503	0.465	0.44
0.6	6	0.92	0.7	0.59	0.54	0.515
0.7	7	1.17	0.83	0.7	0.64	0.6
0.8	8	1.45	1.05	0.835	0.75	0.705
0.9	9	1.9	1.5	1.1	0.95	0.81
1	10	3	1.8	1.5	1.1	0.95
1.1	11	--	--	--	--	--
1.2	12	--	--	--	--	--
1.3	13	--	--	--	--	--
1.4	14	--	--	--	--	--
1.5	15	--	--	--	--	--

Four tables corresponding to different altitudes are provided. Data for up to four altitudes can therefore be input. The values for the altitudes used are propulsion (PROP)-type variable inputs entered in their appropriate section. For increased accuracy, the altitudes chosen for this data should be as close as possible to the flight altitudes in the MP

inputs. There is also a restriction on the flight altitude in the MP inputs in that they cannot exceed the maximum altitude of the SFC data input.

To input the SFC data the user moves the cursor to the desired table and types in the values in the appropriate cells. This is done by pressing the GOTO function key followed by the name of the table. The table names are:

SFCT-SL	--	SFC Table @ Sea Level
SFCT-A1	--	SFC Table @ Altitude 1
SFCT-A2	--	SFC Table @ Altitude 2
SFCT-A3	--	SFC Table @ Altitude 3

Alternatively, the user could use the specific locations indicated on the spreadsheet to get to the desired table(s). For assistance in locating these tables, consult the spreadsheet layout illustrated in Figure 3.1. For guidance on SFC trends, refer to Figure 7.13. SFC data obtained from engine manufacturers is highly recommended for use in both fixed and rubber engine analyses.

B. Variables

As discussed in Chapter 2, there are four types of input variables for the sizing model. These types are: Control (CNTRL), Mission Profile (MP), Aircraft Configuration (AC), and Propulsion (PROP). While the control type inputs are grouped together, the other types of inputs are broken down into groups of related information for ease of use. The following is a detail listing of these variables.

1. Control (CNTRL)

The control-type inputs modify the program mode of operation. This is done by inputting the number 0, 1, or 2 corresponding to the particular alternative and inputting a value for that option, if necessary. There are five control-type input variables in FSM:

- T/W-TO calculation control--varies the method of determination of the take-off thrust loading (T/TOGW).
 - (0)-Program constraints
 - (1)-Input thrust loading at takeoff
 - (2)-Input thrust at takeoff
- W/Sw calculation control--varies the method of determination of the take-off wing loading.
 - (0)-Program constraints
 - (1)-Input wing loading at takeoff

(2)-Input wing area

- **Armor calculation control**--varies the method of determination of aircraft armor weight.

(0)-Program (component armor weight buildup)

(1)-Input % armor weight of TOGW (global)

- **HS configuration control**--determines whether horizontal stabilizer is a canard or conventional tail.

(0)-Canard

(1)-Conventional tail

- **Fuel use control**--determines what type of fuel is used.

(0)-JP-4

(1)-JP-5.

2. Mission Profile (MP)

The mission profile-type inputs follow the generic mission format described previously. The names of most of the mission profile-type inputs contain two elements: a parameter and a leg or segment of the mission. These names are in the following form:

[parameter]-[leg or segment of mission].

The parameters are:

Description	Units	Name
Coefficient of friction	-	MU
Afterburning Factor	-	ABX
Altitude	feet	H
Mach Number	-	MN
Distance	naut.miles or feet	X
Time	hours	T
Delta F [CD/q]	square feet	DF
Payload	pounds	PL
Velocity	knots	V

The generic mission profile is divided into 11 different legs or segments, as shown in Figure 1.1. These segments or legs are:

Number	Description	Name	Segment
1.	Engine start & Takeoff	TO	1 => 2
2.	Climb to Cruise	CL1	2 => 3
3.	Cruise condition	CR1	3 => 4
4.	Loiter condition	LT1	4 => 5
5.	High speed Dash	DS1	5 => 6
6.	Combat condition	CB	6 => 7
7.	High speed Dash	DS2	7 => 8
8.	Climb to Cruise	CL2	8 => 9
9.	Cruise condition	CR2	9 => 10
10.	Loiter condition	LT2	10 => 11
11.	Landing	LD	11 => 12

Together, the parameter and segment establish a unique input whose value is taken at the midpoint of the leg. Certain parameters are specified in each of the mission segments. However, there are also a few other necessary inputs that do not follow this format.

Since many input parameters are similar, such as the altitude and velocity for the different mission segments, references in the manual to the associated tables, figures or charts in Chapter 7 are given for the first occurrence only. For your information, sample mission profiles are displayed in Figure 8.2. These examples display the fact that certain mission requirements are time oriented and/or task oriented. FSM has the capability to handle both types. This is apparent in the combat phase of the generic mission profile.

Takeoff Conditions:

- MU-R--Rolling coefficient of friction, used for takeoff. See Table 7.2 for values for different types of runway surfaces.
- H-TO--Altitude for takeoff (feet).
- X-TO--Maximum allowable take-off ground roll (feet).
- ABX-TO--Additional thrust factor for takeoff; a multiplication factor to compensate for the amount (if any) that take-off thrust is higher than maximum cruise thrust setting at sea level.
- DF-TO--Delta F during takeoff, which is the flat plate drag above the clean configuration (square feet). See Figure 7.1 for an example of incremental drag due to stores. Note that:

$$\Delta F = \Delta C_d \cdot \text{Wing Area} = \frac{\text{Drag}}{q}$$

This is just extra parasite drag and does not include interference effects.

- PL-TO--Payload (expendable) at takeoff (pounds).

- **FRF--Fuel Reserve Factor; usually .05 (5 percent).**

Cruise Conditions:

- **MN-CR1--Mach Number for cruise 1.**
- **H-CR1--Altitude for cruise1(feet).**
- **V-CR1--Velocity for cruise1 (Knots) - NOTE: Velocity is determined from input Mach Number and altitude (above). To see the value, place cell pointer on that cell and push the edit function key then the arrow down key. Note that this input is the true airspeed. See Figure 7.2 for the equivalent (indicated) airspeed.**
- **X-CR1--Distance for cruise1 (nautical miles).**
- **DF-CR1--Delta F for cruise1(square feet).**
- **PL-CR1--Payload (expendable) for cruise1 (pounds).**

Loiter Conditions:

- **H-LT1--Altitude for loiter1 (feet).**
- **T-LT1--Time for loiter1 (hours).**
- **DF-LT1--Delta F for loiter1 (square feet).**
- **PL-LT1--Payload (expendable)for loiter1 (pounds).**

NOTE: V-LT1, MN-LT1 determined for optimum conditions.

Dash Conditions:

- **MN-DS1--Mach Number for dash1.**
- **H-DS1--Altitude for dash1 (feet).**
- **V-DS1--Velocity for dash1 (knots) ; See V-CR1!!**
- **X-DS1--Distance for dash1 (nautical miles).**
- **DF-DS1--Delta F for dash1 (square feet).**
- **PL-DS1--Payload (expendable) for dash1 (pounds).**

Combat Conditions:

- **MN-CB--Mach Number for combat.**
- **H-CB--Altitude for combat (feet).**
- **V-CB--Velocity for combat (knots) ; See V-CR1!!**
- **DF-CB--Delta F for combat (square feet).**
- **PL-CB--Payload (expendable) for combat (pounds).**

- **TR--Turn Rate (sustained, degrees per second) required at combat velocity. See Figure 7.3 for turn conversion chart.**

Additional combat phase inputs are divided into two parts: Time Oriented (no specific tasks) and Task Oriented.

Time Oriented:

- **T-CB--Time for combat (hours); No specific tasks required.**

Task Oriented:

- **PLF--Popup Load Factor; load factor encountered recovering to level or climbing flight from a dive in the vertical plane.**
- **NP--Number of passes (360 degree turns) at a target.**
- **DELTE--Delta specific energy (ft.lbf/lbm) in popup.**
- **V-MINCB--Minimum combat velocity (kts).**
- **NVMINCB--Load factor at minimum combat velocity.**

Dash2 Conditions:

- **MN-DS2--Mach Number for dash2.**
- **H-DS2--Altitude for dash2 (feet).**
- **V-DS2--Velocity for dash2 (knots) ; See V-CR1!!**
- **X-DS2--Distance for dash2 (nautical miles).**
- **DF-DS2--Delta F for dash2 (square feet).**
- **PL-DS2--Payload (expendable) for dash2 (pounds).**

Cruise2 Conditions:

- **MN-CR2--Mach Number for cruise2.**
- **H-CR2--Altitude for cruise2 (feet).**
- **V-CR2--Velocity for cruise2 (knots) ; See V-CR1!!**
- **X-CR2--Distance for cruise2 (nautical miles).**
- **DF-CR2--Delta F for cruise2 (square feet).**
- **PL-CR2--Payload (expendable) for cruise2 (pounds).**

Loiter2 Conditions:

- **H-LT2--Altitude for loiter2 (feet).**
- **T-LT2--Time for loiter2 (hours).**
- **DF-LT2--Delta F for loiter2 (square feet).**

- PL-LT2--Payload (expendable) for loiter2 (pounds).

NOTE: V-LT2, MN-LT2 determined for optimum conditions.

Landing Conditions:

- MU-B--Braking Coefficient of friction, used for Landing.
- H-LD--Altitude for landing (feet).
- X-LD--Maximum allowable Landing Ground roll (feet).
- DF-LD--Delta F for landing (square feet).
- PL-LD--Payload (expendable) for landing (pounds).

3. Aircraft Configuration (AC)

The Aircraft Configuration type inputs consist of certain weight information, dimensional information, and aerodynamics/structural information. The inputs in these groups are discussed in the following section.

Weight Information:

The first set of inputs are the Material Technology Factors (MTF-[xxx]) for the aircraft components. They are used to determine the weight savings from using advanced composite materials rather than conventional metals. The components considered are:

Component	[xxx]
Wing	W
Fuselage	F
Landing Gear	LG
Flight Controls	FC
Systems	SYS
Vertical & Horizontal Stabilizer	VHS

Entering 1 for each of the MTF's is the baseline case of 100% conventional material. An estimate of the weight savings from using composite materials is shown in Figure 7.4.

The second set of inputs in this group are the percent of armor usage (% ARMUSE-[xx]) in various sections of the aircraft. The sections considered are:

Section	[xx]
Cockpit	C
Fuel System	FS
Engine	ENG
Flight Controls	FC
Miscellaneous	M

For this set of inputs "100" means 100% armor use, and "0" means 0% armor use for that section. However, these inputs can be bypassed by setting the armor calculation control (ARMCNTRL) to 1. This allows the input of a fixed percentage of the take-off gross weight (TOGW) to be allocated for aircraft armor.

The rest of the inputs in this group are self-explanatory and are listed below.

- ARMDEN--Density of the armor used (lb/square feet). See Table 7.3 for a listing of armor material densities for varying levels of ballistic protection.
- AVNCS--Avionics fixed (non-expendable) installed weight (pounds).
- ARMNT--Armament fixed (non-expendable) installed weight (pounds).
- NCR--Number of crew ; 0 <UAV>, 1 or 2.

Dimensional Information:

NOTE: See Figures 7.5-7.10 and Table 7.4 for assistance for inputs in this group.

- LAMDA--Wing taper ratio (tip chord/root chord); 0-1.0.
- SWEEP--Wing quarter chord sweep (degrees); 0-40.
- T-C--Wing average thickness in percent of chord; .03-.16.
- AR--Wing aspect ratio (span squared/wing area); 2-6.
- FL--Fuselage length (feet). Fuselage must be long enough for the cockpit, engine, fuel, etc.
- FD--Fuselage equivalent diameter, average (feet). For non-circular fuselages use: Equiv. Dia. = SQRT(cross sectional area/.7854).
- FWAF--Fuselage wetted area factor. Used to determine wetted area by the formula below:

$$\text{Wetted Area} = \text{FWAF} \cdot (\text{PI} \cdot .5 \cdot \text{FD}^2 \cdot \text{FL})$$

A reasonable range of this value is .80 - .90.

- NCG/FL--Nose-to-center of gravity distance/FL.
- NWB/FL--Nose to wing-body aero. center distance/FL.
- NVS/FL--Nose-to-vertical stabilizer distance/FL.
- VSVC--Vertical stabilizer volume coefficient; .06-.12.
- VSAR--Vertical stabilizer aspect ratio; 1-2.
- NHS/FL--Nose-to-horizontal stabilizer distance/FL.
- HSOD--Horizontal stabilizer vertical offset distance from wing (feet).
- HSAR--Horizontal stabilizer aspect ratio; 2-6.

Aerodynamics/Structural Information:

- ESR--Equivalent sand roughness; see Table 7.5 for typical values.
- CL-MIN--Coefficient of lift at CD min (camber effects); 0-.3.
- FSWS--Flap Span to Wing Span ratio; usual values: .5-1.

- **SSWS**--Slat span to wing span ratio; usual values: .5-1.
- **SM**--Static Margin of the aircraft; 0 -.05.
- **MN-MAX**--Maximum structural Mach number at sea level; used for empty weight calculations, not performance.
- **NL**--Limit load factor (Ultimate load factor = 1.5 [1.2 for UAV] • NL); 7.3 - 9+
- **MISCDRAG**--Miscellaneous flat plate (F) drag (square feet); see Figure 7.11 for example values.
- **INTERF**--Interference factor; drag multiplication factor to account for global interference effects. Effect of this factor is displayed in Figure 7.12. Typical range of values is 1.0 - 1.05.

4. Propulsion (PROP)

Propulsion Information:

NOTE: Values for ALT1, ALT2, ALT3 must be input in ascending order!

- **ALT1**--Altitude for first SFC data entry (feet).
- **ALT2**--Altitude for second SFC data entry (feet).
- **ALT3**--Altitude for third SFC data entry (feet).
- **T/W-ENG**--Thrust (max. cruise or intermediate rating) to weight of the engine, installed; 3-9.
- **TRF**--Thrust reversal factor; percent reverse engine thrust capability--enter 0 for zero capability, 1 for 100% thrust reversing capability.
- **FCF**--Fuel calculation factor; "fudge" factor to account for losses, etc., 1-1.05.

The final inputs in the propulsion information group are the lapse rate slopes of thrust vs. Mach number (LRMS-[xxx]) at the different altitudes and the thrust degradation ($T[\text{alt.}\#]/[\text{alt.}\#]$) between the various altitudes. These inputs are defined in the following manner:

$$\text{LRMS} - [\text{xxx}] = \frac{dT}{dM} = \frac{[-T(M=0) + T(M=1)]}{T(M=0)}$$

$$\frac{T[\text{alt.}\#]}{[\text{alt.}\#]} = \frac{T(\text{alt.}\#)}{T(\text{alt.}\#)}$$

The general trends of these parameters as well as SFCs are shown in Figure 7.13.

It must be reiterated that the data ranges and trends contained in this manual are for estimation only. Obtaining more accurate data which are specific to a particular application is highly recommended. Also, some of the variables are dependent on each another. When a certain input variable is changed, it is important to ensure that no other inputs are affected. This point is vital for accuracy of the model.

3.4 Outputs

The primary output of Fighter Aircraft Sizing Model are broken up into two parts:

- Sizing Output--Lists all calculated variables and tables in the order obtained.
 - Initial Calculations
 - Average Cruise Conditions
 - Lift Curve Slope Calculations
 - Vertical/Horizontal Stabilizer Sizing
 - Clean Zero-lift Drag Coefficient (CDo)
 - Phase Zero-lift Drag
 - Cruise/Loiter Optimum Conditions
 - Transonic Drag Rise Calculations
 - Static Wing Loading Calculations
 - Loiter Conditions
 - Load Factors
 - Required Lift Coefficient Calculations
 - Resultant Drag Coefficient Calculations
 - Thrust Required - Drag Levels
 - Lift/Drag Values
 - Engine Data - Phase Altitude Breakdown
 - Required Take-off Thrust loading Levels
 - Engine Thrust Available Levels
 - Engine Cruise Power Settings
 - Breguet Range Calculations
 - Take-off and Landing Calculations
 - Aircraft Empty Weight Calculations
- Sizing Summary--Lists certain specific inputs and calculated outputs of primary interest.

A brief description of each output variable within the group or task is included in the spreadsheet.

The sizing summary includes a brief listing of the pertinent weight, sizing, and mission information derived from FSM. In addition, the run name and number is copied from the input section for reference purposes. The "delta" parameter in the upper right-hand corner shows the iteration status. This is the change in Takeoff Gross Weight (TOGW) with successive iterations. When this value diminishes to .5 or lower, the model stops.

In addition to the two primary outputs of FSM, there are also two sets of data included in this spreadsheet. These are the inputs/outputs of FSM that are required in the performance models, RPM and EMM. To use the data generated in FSM in these models without manually inputting them, the data transfer macro is initiated from RPM and EMM. This is done with the following command: ALT T--alt key then the T key.

4. RANGE-PAYLOAD MODEL (RPM)

4.1 Purpose

The purpose of RPM is to investigate the range-payload performance of the aircraft sized in FSM. The design point for the Sizing Model is at the "knee" of the range payload curve, shown in Figure 4.1. Since the principle outputs of this model are the cruise radius (X-CR) and the mission radius (X-MSN), mission profile tradeoffs can be done with RPM. This is done independently, using the fixed aircraft configuration found by FSM.

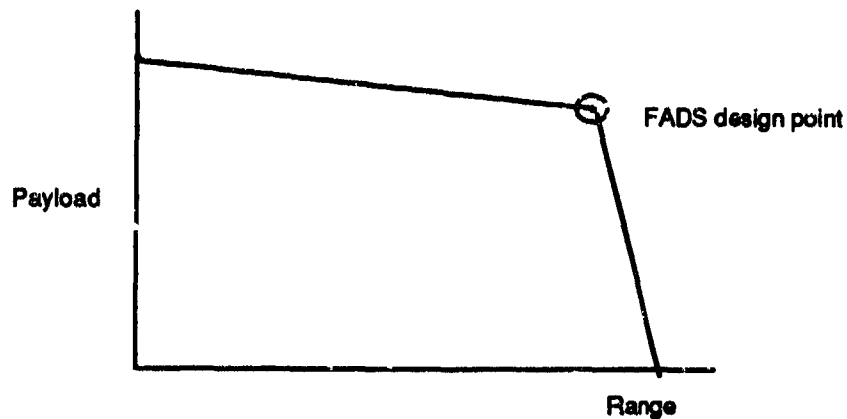

Figure 4.1. Typical Range-Payload Curve

4.2 Architecture

The Range-Payload Model is similar to FSM in that it is comprised of many different elements. The spreadsheet architecture for this model is shown in Figure 4.2. The cell location A1 or the spreadsheet "home" is at the upper left corner of the header. When RPM is retrieved, this is the default cell pointer position. Again, this figure shows the various elements and their relative position in the RPM spreadsheet and is not to scale. The recalculation is also manual and proceeds in a row-wise fashion.

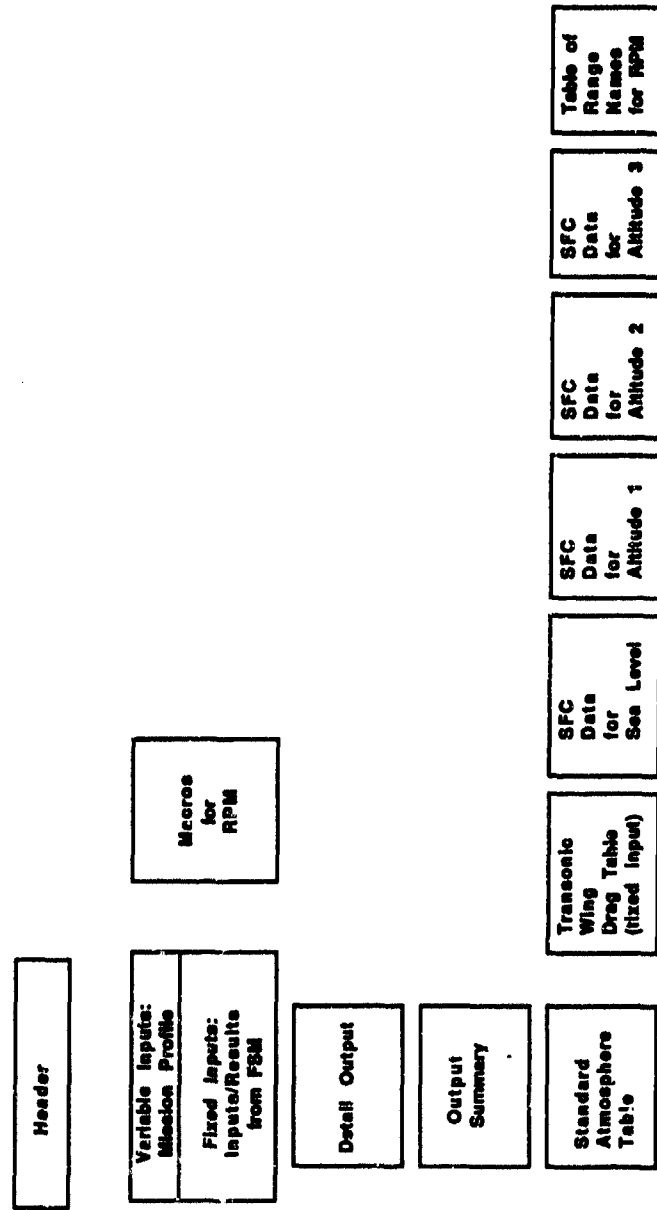

Figure 4.2. Range-Payload Model Architecture

4.3 Inputs

A. Tables

The tables in the Range-Payload Model RPM are the same as those used in FSM: atmosphere characteristics and specific fuel consumption. They are entered as needed in the same way as in FSM. The data transfer macro in RPM only moves the necessary variable inputs/results from FSM to RPM. Thus, the data in the tables must be input manually. Note that the standard atmosphere is already entered, so unless it is desirable to use values other than these, this table need not be altered.

B. Variables

In this model, there are fewer variable inputs than in FSM. The input variables that are in this model are all mission profile type and identical to their counterparts in FSM except for the one new input--fuel.

- FUEL--Total fuel weight (pounds).

Since the MP variables in RPM are the same as those in FSM, Section 3.3 would be helpful as a reference for inputting the values to these variables. Note that in this model the cruise distances and therefore the mission distance are not required inputs. They are results of RPM. There is a check in the model to see whether the sum of the payload at takeoff and fuel weight--the useful load--is in excess of that for the sized aircraft from FSM. Therefore, it is necessary to add the required Delta F (drag) to account for external fuel tanks if more fuel is desired than this restriction allows.

The remaining inputs to this model are select FSM inputs and results. These are obtained by either using the data transfer macro from FSM or by manually entering them into the spreadsheet. This model assumes that the aircraft is sized from FSM, so these inputs are fixed.

4.4 Outputs

The output of this model is similar to that of FSM in that there are two parts:

- Range-Payload Output--Lists all calculated variables and tables in order obtained.
- Range-Payload Summary--Lists certain specific inputs and calculated outputs of primary interest.

As with FSM, the detail output is broken down into groups of related information, or into similar tasks. Most of these groups are the same as in FSM. Both output parts also include brief descriptions of the generated data. However, as previously mentioned, the major output from this model is the cruise radius.

With the achievable cruise distance, the total mission radius is found by adding the input dash radius. Thus, various mission profile trades can be conducted to investigate the range-payload performance of the sized aircraft. The ramifications of these trade-offs to combat turn rate and takeoff and landing performance is readily ascertained.

5. ENERGY/MANEUVERABILITY MODEL (EMM)

5.1 Purpose

The purpose of this model is to examine the energy/maneuverability traits of the sized, fighter-type tactical aircraft. Examples of these traits include: sustained (constant speed and altitude) turn rate, instantaneous (loss of speed and/or altitude) turn rate, and maximum speed. These traits are encompassed within many of the aircraft static and dynamic flight capabilities.

The traits can be presented by a number of selective graphs. By comparing these graphs for different aircraft, an assessment can be made regarding their relative merits. By including the mission requirements in the comparison, the superiority of one design over another can be ascertained. The output of this model provides a table that includes many of the parameters necessary to show the desired flight capability.

5.2 Architecture

The architecture of the Energy/Maneuverability Model is similar to the structure of FSM and RPM. This is exhibited in Figure 5.1. EMM also uses a row-wise calculation procedure. However, EMM does not require any iterations to get the output for a particular altitude. Since many of the traits vary with altitude, it may be advantageous to run the model with multiple altitudes.

5.3 Inputs

A. Tables

As previously mentioned, EMM does not require the Specific Fuel Consumption Tables to operate successfully. Therefore, unless it is desirable to run an analysis with a non-standard atmosphere, there are no tables to input. This is because the standard atmosphere is already entered for the atmosphere characteristics table.

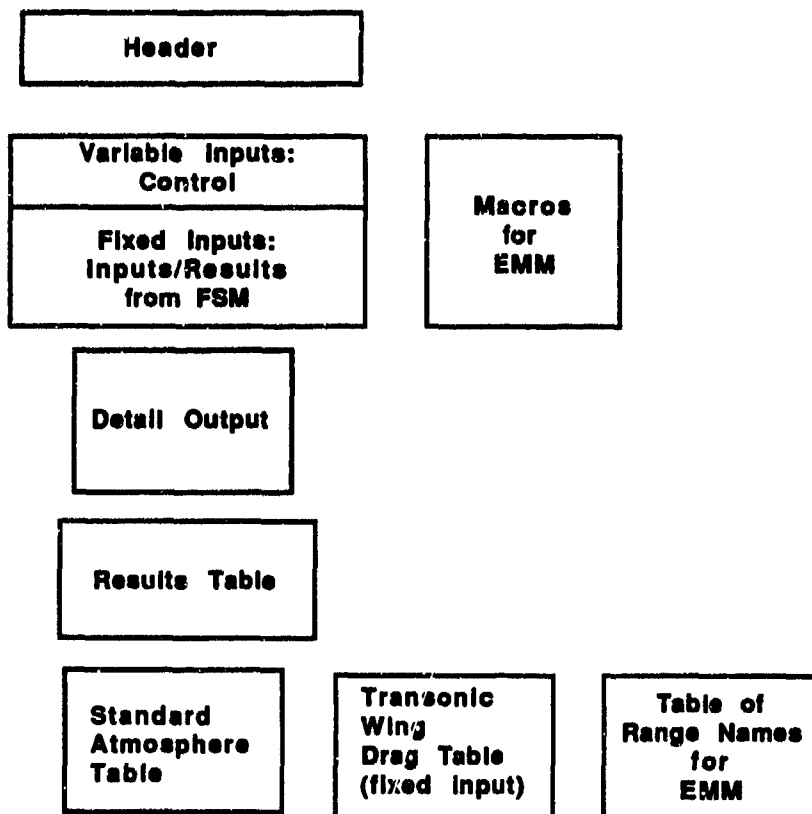

Figure 5.1. Energy/Maneuverability Model Architecture

B. Variables

The Energy/Maneuverability Model contains control (CNTRL) type variable inputs as well as the required inputs and results from FSM. The following CNTRL type inputs define the bounds for the Energy/Maneuverability Model:

- V-IN--Initial velocity (knots); lowest velocity to examine energy/maneuverability traits.
- DELTV--Delta velocity (knots); increments of velocity to examine energy/maneuverability traits.

NOTE: The output table contains 12 velocity points.

- H-CB--Altitude to examine (feet).
- ABX--Additional thrust factor; thrust multiplication factor for combat. See ABX-TO input in FSM!

5.4 Outputs

The output of EMM, like FSM and RPM, contains two parts:

- Energy/Maneuverability Output--Lists all calculated variables and tables in order obtained.
- Energy/Maneuverability Summary--Contains the table of results from EMM and other pertinent output data.

The detail output is also separated into different groups of related information, or into similar tasks. However, these groups are somewhat different from those in FSM and RPM. This is because the model studies the aircraft performance over a range of velocities for the combat phase, rather than over the mission profile, as is done in FSM and RPM. A brief description of the output produced within these groups is included.

The summary output of EMM is comprised of a large table of aircraft performance traits over a range of velocities for the combat phase, and other pertinent output, such as an estimate of important aircraft velocities (maximum, minimum). This output facilitates the use of graphs to compare different aircraft designs. The parameters can be plotted as a function of velocity and altitude to obtain the aircraft flight envelope and performance within that envelope.

A menu of selected graphs for one altitude (H-CB) is obtained by using the graph macro. This macro is initiated with the following command: ALT G -- alt key then the G key. Example performance plots are the aircraft turn rate versus velocity and excess specific power versus velocity.

6. COST ESTIMATION MODEL (CEM)

6.1 Purpose

The purpose of CEM is to determine the following approximate aircraft costs:

- Research, Development, Test and Evaluation (RDT&E)
- Flyaway
- Procurement.

6.2 Architecture

CEM, shown in Figure 6.1, is a very simple model. There are no tables, and only six variable inputs are required. As with EMM, no iterations are necessary.

6.3 Inputs

The following are the six variable inputs for CEM:

- IOC--Initial Operating Capability Calendar Year; Last two digits up to '99.
- N--Number of aircraft to procure.
- SERV--Aircraft Service:
 - (1) Air Force
 - (2) Navy
 - (3) Army
- OWE--Operating Weight Empty; result from FSM.
- T--Maximum thrust; result from FSM.
- VMAX--Maximum velocity at best altitude; result from EMM.

6.4 Outputs

CEM calculates the Defense Contractors Planning Report (DCPR) Weight from the input OWE and uses it in Cost Estimating Relationships (CERs) taken from Reference 17 to determine the aircraft RDTE, Flyaway, and procurement costs. The output of CEM lists these costs, which are in millions of FY85 dollars.

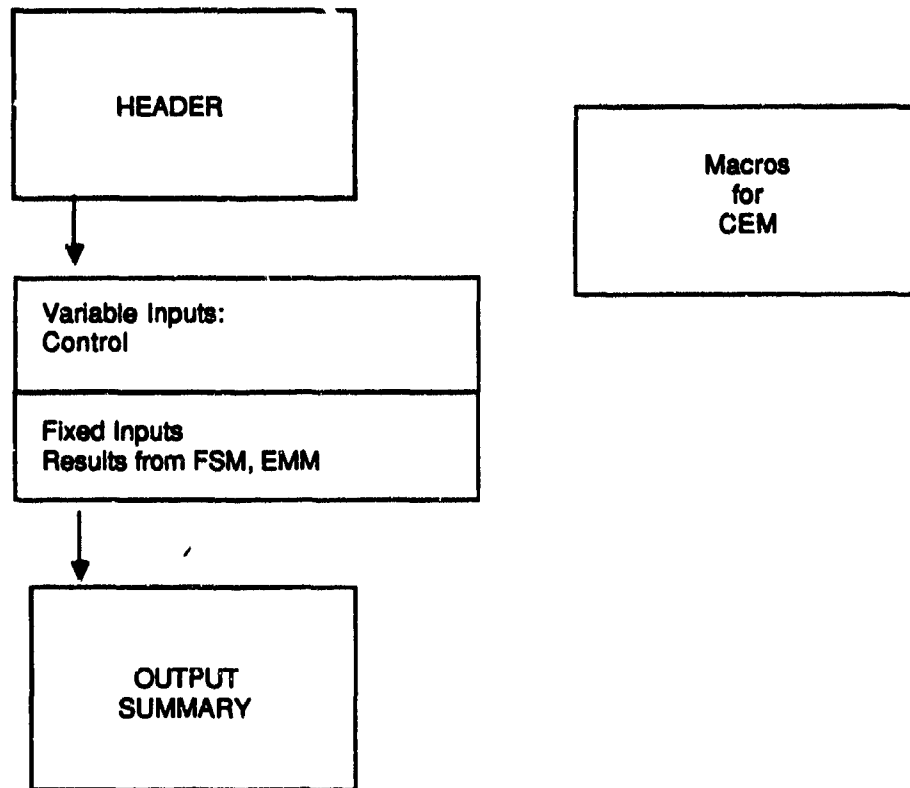

Figure 6.1. Cost Estimation Model Architecture

7. SUPPLEMENTAL FADS INFORMATION

7.1 Input Aids

This section contains various tables and figures that are helpful to choose realistic values for the inputs in FADS. Certain data in the input aids are only estimates of their true range values. Therefore, care should be taken when using them. New information should be correlated with the data in this section to improve the accuracy of FADS. Table 7.1 is particularly useful and displays a variety of information about current aircraft. It gives an overview of the relative magnitude of various parameters associated with current combat aircraft that are compatible with FADS.

A. Tables

Table 7.1. Selected Aircraft Characteristics

AIRCRAFT	REFERENCE WING AREA -S (FT ²)	WING ASPECT RATIO -AR	WING TAPER RATIO -λ	WING C/4 SWEEP -Λ _{1/4} (DEG.)	WING THICKNESS RATIO -t/c	NUMBER OF CREW -N _c
F-1E	338.7	4.59	0.236	35.0	0.060	1
F-4E	533.0	2.73	0.183	45.0	0.047	2
F-5E	175.0	3.75	0.200	24.0	0.048	1
F-6E	375.0	3.40	0.277	42.0	0.0575	1
F-9J	337.0	3.53	0.500	35.0	0.0965	1
F-11A	235.0	3.92	0.500	37.0	0.50	1
*F-11	565./1150.	7.22/1.22	.263/.100	18.5/63.0	.110/.0635	2
F-15	699.4	3.00	0.250	39.6	0.047	1
YF-16	250.0	3.00	0.230	32.0	0.040	1
YF-17	350.0	3.50	0.350	29.0	0.045	1
F-34E	321.7	3.47	0.500	40.0	0.024	1
F-83D	257.9	4.79	0.513	35.0	0.0921	1
F-83F	287.9	4.79	0.515	35.0	0.0921	1
F-100C	390.0	3.80	0.263	45.0	0.070	1
F-101B	300.0	4.25	0.204	36.5	0.062	1
F-102A	635.0	2.13	0.090	52.2	0.040	1
F-104A	196.6	2.53	0.377	18.3	0.036	1
F-105D	385.0	3.10	0.457	45.0	0.0475	1
F-105B	650.0	2.10	0.070	52.2	0.0385	1
*F-111A	525./1010.	7.55/1.01	.325/.190	12.0/67.0	.092/.0576	2
*F-111B	550./1035.	8.91/1.01	.250/.100	12.0/67.0	.092/.0576	2
F3H-24	519.0	2.40	0.500	45.0	0.030	1
F4U-1	557.0	2.01	0.332	46.3	0.0575	1
F7U-3	426.0	2.95	0.330	35.0	0.098	1
F8U-3	462.0	3.43	0.230	42.0	0.0455	1
EA-3B	812.0	6.47	0.353	36.0	0.088	3
A-4C	259.0	2.92	0.226	33.2	0.065	1
A-5A	700.0	4.00	0.230	37.5	0.050	2
EA-5C	753.7	3.73	0.105	37.5	0.046	2
A-6A	523.9	5.31	0.312	25.0	0.075	2
A-7A	375.0	4.00	0.250	35.0	0.070	1
YA-9	560.0	5.80	0.475	5.0	0.160	1
YA-10	600.0	5.00	0.505	5.0		1
T-2D	255.0	5.70	0.500	3.5	0.120	2
VIGGEN	525.0	2.30	0.050	45.0	0.040	1
*H. IIIG	267.7/321.7	6.00/1.65	-	20.0/63.0	.110/.051	2
HARRIER	201.0	3.20	0.336	34.0	0.035	1

*Unswept/swept values

Source: Reference 15.

Table 7.1. Continued

AIRCRAFT	TAKEOFF GROSS WEIGHT -W _{TO} (LB)	WEIGHT EXCLUDING EXTERNAL STORES -W _{EES} (LB)	NUMBER OF ENGINES -N _E	NUMBER OF INLETS -N _I	TOTAL MAXIMUM THRUST (SLS, UHIST) -T _{MAX} (LB)	TOTAL INTERMEDIATE THRUST (SLS, UHIST) -T _{MIL} (LB)
F-1E	20130.	20130.	1	1	7700.	7700.
F-4E	47732.	45917.	2	2	34000.	21800.
F-5A	13063.	13347.	2	2	8160.	5440.
F-8E	27592.	26067.	1	1	18000.	10700.
F-9J	20990.	20990.	1	2	7250.	7250.
F-11A	20012.	20012.	1	2	10500.	7450.
F-14	53393.	51953.	2	2	56200.	32900.
F-15	39769	37729.	2	2	48138.	28234.
YF-16	17518.	16988.	1	1	23600.	14117.
YF-17	18800.	17270.	2	2	28800.	19968.
F-24F	20200.	20200.	1	1	7800.	7800.
F-85D	18192.	18192.	1	1	6830.	6630.
F-86F	14992.	14992.	1	1	5970.	5970.
F-100C	28620.	28520.	1	1	16000.	10200.
F-101B	45405.	45405.	2	2	33800.	21400.
F-102A	27977.	27977.	1	2	16000.	10200.
F-104A	17879.	17879.	1	2	15600.	10000.
F-105D	37203.	37203.	1	2	24500.	16100.
F-106B	35924.	35924.	1	2	24500.	16100.
F-111A	80979.	80979.	2	2	40300.	21500.
F-111B	79340.	69675.	2	2	40300.	21500.
F3H-2H	21963.	21963.	1	2	14500.	10200.
F4D-1	21467.	20793.	1	2	16000.	10200.
F7U-3	31642.	31642.	2	2	9200.	9200.
F8U-3	38512.	37192.	1	1	26000.	16500.
EA-3B	78175.	78175.	2	2	21000.	21000.
A-4C	19512.	15550.	1	2	8500.	6500.
A-5A	55748.	55748.	2	2	35718.	23340.
RA-5C	64319.	64319.	2	2	34000.	23340.
A-6A	43626.	41505.	2	2	17000.	17000.
A-7A	36703.	27018.	1	1	11350.	11350.
YA-9	39570.	28310.	2	2	14400.	14400.
YA-10	45825.	34077.	2	2	18400.	18400.
T-2B	13111.	13111.	2	2	6000.	6000.
VIGGEN	37885.	30009.	1	2	24000.	14000.
M. IIIG	39700.	39700.	1	2	19284.	13000.
HARRIER	15700.	14780.	1	2	18800.	18800.

Table 7.1. Continued

AIRCRAFT	TOTAL AIRCRAFT VOLUME -V _{TOTAL} (FT ³)	VOLUME OF LIFTING SURFACES -V _{SURFACES} (FT ³)	FUSELAGE VOLUME -V _{FUSELAGE} (FT ³)	MAXIMUM FUSELAGE BREADTH -B _F (FT)	MAXIMUM FUSELAGE HEIGHT -H _F (FT)	MAXIMUM FUSELAGE LENGTH -L _F (FT)
F-1E	-	-	-	5.0	7.0	36.42
F-4E	1689.	216.	1473.	8.7	6.3	59.08
F-5A	546.	39.	507.	5.9	5.2	45.0
F-8E	1240.	177.	1063.	5.0	6.6	52.8
F-9J	829.	274.	555.	9.75	5.85	42.0
F-11A	728.	71.	647.	6.0	5.85	44.8
F-14	2455.	359.	2096.	14.4	7.15	60.5
F-15	-	-	-	12.0	6.82	65.5
YF-16	727.6	-	-	4.6	6.48	46.0
YF-17	848.3	127.4	720.9	6.9	5.6	40.0
F-84F	-	-	-	4.15	7.0	38.4
F-86D	-	-	-	5.0	6.6	37.0
F-86F	-	-	-	5.0	6.35	34.2
F-100C	1090.	181.	909.	5.6	6.0	44.4
F-101B	1692.	132.	1560.	12.1	7.7	66.9
F-102A	1597.	276.	1321.	6.65	6.9	52.3
F-104A	823.	43.	780.	7.1	5.25	52.3
F-105D	1436.	147.	1289.	9.95	7.41	64.36
F-106B	1701.	279.	1422.	8.1	7.32	67.0
F-111A	2996.	274.	2722.	12.17	7.14	70.55
F-111B	2935.	279.	2656.	12.17	7.14	63.67
F3H-2N	1294.	353.	941.	5.7	7.0	57.0
F4D-1	945.	360.	585.	8.1	6.1	40.7
F7U-3	-	-	-	7.0	7.1	39.5
F8U-3	1823.	197.	1626.	6.8	7.35	57.91
EA-3B	3601.	655.	2537.	7.17	7.67	69.17
A-4C	596.	130.	565.	5.85	5.30	38.80
A-5A	2304.	276.	2028.	10.75	5.70	69.0
RA-5C	2790.	292.	2498.	10.75	6.70	70.5
A-6A	1589.	309.	1280.	8.3	9.0	52.9
A-7A	1228.	156.	1072.	4.95	7.21	44.2
YA-9	-	-	-	4.09	6.9	52.6
YA-10	-	-	-	5.67	7.1	54.66
T-2B	728.	172.	569.	4.4	7.0	35.2
Viggen	1359.6	262.6	1097.	8.1	6.15	50.0
M. III	1287.	129.	1158.	9.17	7.09	52.5
Harrier	-	-	-	6.9	5.6	40.0

Table 7.1. Continued

AIRCRAFT	TOTAL FUEL -W _F (LB)	FUSELAGE FUEL -W _F FUSELAGE (LB)	WING FUEL -W _F WING (LB)	ENGINE* LENGTH -L ENG (IN)	ENGINE DIAMETER -D ENG (IN)	CAPTURE AREA -A _C (FT ²)
F-1E	5712.	4537.	1125.	125.0	37.5	3.2
F-4E	12896.	8800.	4096.	208.7	39.1	8.61
F-5A	3790.	3790.	0.0	109.9	20.4	2.07
F-8E	8250.	4500.	3750.	267.0	40.0	4.16
F-9J	6378.	5500.	878.	144.0	51.0	3.2
F-11A	5940.	4730.	1210.	181.0	37.5	4.8
F-14	14340.	-	-	199.7	50.5	14.6
F-15	-	-	-	184.1	45.0	-
YF-16	5700.	4900.	800.	191.5	45.0	5.55
YF-17	5600.	-	-	149.0	-	6.33
F-84F	-	-	-	86.0	38.9	-
F-86D	-	-	-	-	-	2.43
F-86F	-	-	-	129.0	34.0	2.36
F-100C	7729.	5000.	2729.	242.0	40.0	5.0
F-101B	13546.	12300.	1246.	253.0	40.0	-
F-102A	7053.	0.0	7053.	235.0	40.0	3.84
F-104A	4960.	4960.	0.0	209.0	35.3	4.7
F-105D	7540.	7540.	0.0	259.0	43.0	6.66
F-106B	9386.	1150.	8236.	238.0	43.0	-
F-111A	32155.	27100.	4056.	242.3	36.7	16.85
F-111B	23462.	17100.	6362.	242.3	36.7	16.85
F3H-2II	-	-	-	287.0	43.0	3.72
F4D-1	4160.	0.0	4160.	250.0	40.5	4.28
F7U-3	-	-	-	-	-	-
F8U-3	14306.	9060.	5246.	259.0	43.0	5.7
EA-3B	33144.	24444.	8700.	158.0	41.0	-
A-4C	5440.	1800.	3640.	244.0	31.0	-
A-5A	19074.	10034.	9040.	208.5	31.6	12.2
RA-5C	22474.	11214.	6725.	208.5	31.6	12.2
A-6A	15939.	11214.	6725.	221.0	30.0	-
A-7A	10200.	5280.	4920.	128.0	42.0	7.07
YA-9	9000.	-	-	82.0	40.0	-
YA-10	-	-	-	-	-	-
T-2B	4492.	2520.	1972.	-	-	-
VIGGEN	-	-	-	238.0	43.0	6.0
M. IIIG	10400.	8960.	1440.	255.0	57.0	9.0
HARRIER	5000.	-	-	123.0	48.0	9.2

*Includes Tail Pipe

Table 7.1. Continued

AIRCRAFT	NUMBER OF VERT. TAIL -N _{VT}	EXPOSED VERT. TAIL AREA -S _{VT} (FT ²)	EXPOSED HOR. TAIL AREA -S _{HT} (FT ²)	SPEED BRAKE AREA -S _{SB} (FT ²)	LANDING CONFIG. C _L MAX -C _L MAX	MAXIMUM MACH NO. AT 35K -M _{DES}
F-1E	1	34.7	42.2	10.8	1.21	0.96
F-4E	1	68.0	85.0	18.6	1.34	2.20
F-5A	1	41.3	31.8	6.42	1.30	1.00
F-8E	1	75.0	59.0	16.3	1.17	1.71
F-9J	1	49.1	49.9	-	1.15	0.916
F-11A	1	50.0	42.0	7.1	1.53	1.12
*F-14	2	118.0	140.0	-	2.52	.8/2.4
F-15	2	125.2	120.0	-	1.77	2.5
YF-16	1	54.75	42.5	13.96	1.57	2.0
YF-17	2	104.0	94.0	-	1.60	2.0
F-84F	1	39.6	55.8	-	1.12	0.924
F-86D	1	36.4	39.5	-	1.46	0.940
F-86F	1	36.5	35.3	-	1.59	0.908
F-100C	1	63.2	67.4	14.14	1.22	1.4
F-101B	1	78.0	75.0	17.3	1.00	1.85
F-102A	1	95.0	0.0	12.5	0.85	1.18
F-104A	1	43.0	48.0	8.2	1.26	2.0
F-105D	1	63.0	60.4	29.0	1.44	2.08
F-106B	1	88.0	0.0	17.0	0.85	2.0
*F-111A	1	112.0	174.3	26.5	3.27	.8/2.08
F-111B	1	112.0	154.0	26.3	3.27	.8/2.08
F3H-2N	1	47.9	73.5	15.0	1.29	0.955
F4D-1	1	47.7	0.0	10.4	0.945	0.96
F7U-3	2	106.8	0.0	-	1.20	0.925
F8U-3	3	116.2	65.0	13.94	1.38	2.20
EA-3B	1	145.0	139.0	40.0	1.58	0.91
A-4C	1	55.0	45.0	8.75	1.41	0.90
A-5A	1	101.0	172.0	-	1.34	2.0
RA-5C	1	101.0	172.0	-	1.83	2.0
A-6A	1	75.0	104.0	18.5	2.15	0.83
A-7A	1	71.0	56.0	25.0	1.44	0.833
YA-9	1	98.0	153.0	-	1.60	0.68
YA-10	2	125.0	118.0	-	-	0.68
T-2B	1	36.6	72.0	-	1.56	0.776
Viggen	1	106.0	178.0	-	-	2.16
*M. III G	1	67.75	78.15	13.56	-	- /2.0
Harrier	1	51.6	47.54	8.5	1.20	0.9

*Unwept/swept values

Table 7.1. Concluded

AIRCRAFT	TOTAL NETTED AREA - S_{NET} (FT ²)	MAXIMUM CROSS- SECTIONAL AREA - S_{MAX} (FT ²)	NET* CROSS- SECTIONAL AREA - S_{NET} (FT ²)	C_{r_0}	$(\frac{D}{q})_{SUBSONIC}$
F-1E	-	-	-	-	-
F-4E	2106.	53.71	45.1	.00453	9.55
F-5A	948.	18.57	16.50	.00341	3.23
F-8E	1796.	38.0	33.84	.0030	5.40
F-9J	1329.	-	-	-	-
F-11A	1145.	33.2	28.4	.0034	3.90
F-14	-	63.4	48.8	-	10.4
F-15	-	-	-	-	-
YF-16	1322.6	27.05	21.5	.00391	5.16
YF-17	1807.	32.33	26.0	.00348	6.30
F-84F	-	-	-	-	-
F-86D	-	-	-	-	-
F-86F	-	-	-	-	-
F-100C	1553.	40.8	35.8	.00341	5.30
F-101E	2027.	-	-	.0035	7.10
F-102B	2090.	49.0	45.15	.0035	7.30
F-104A	1128.	22.2	17.3	.0036	4.05
F-105D	1915.	43.62	36.96	.0036	6.90
F-106B	2196.	-	-	.0030	6.59
F-111A	3191.	69.4	52.6	.0037	11.80
F-111B	3152.	69.4	52.6	.0039	12.30
F3H-2N	1778.	41.12	37.4	.0031	5.5
F4D-1	1515.	54.28	50.00	.0037	5.6
F7U-3	-	-	-	-	-
F8U-3	2270.	48.0	42.3	.0033	7.5
EA-3B	4124	-	-	.00371	15.30
A-4C	1094.	-	-	.0039	4.26
A-5A	2287.	-	-	.0036	10.40
RA-5C	3091.	63.5	51.3	.0036	11.10
A-6A	2217.	-	-	.0043	9.53
A-7A	1643.	31.13	38.2	.0035	5.75
YA-9	-	-	-	-	-
YA-10	-	-	-	-	-
T-28	1249.	-	-	-	-
VIGGEN	-	41.6	35.6	-	-
M. III G	1610.	40.0	31.0	-	-
HARRIER	1007.	-	-	.00381	3.84

* $S_{NET} = S_{MAX} - A_C$

Table 7.2. Rolling/Braking Coefficient of Friction Values

Rolling and Braking Coefficient of Friction Values for Different Types of Runway Surfaces		
<u>Surface Type</u>	<u>Average Rolling Coefficient</u>	<u>Average Braking Coefficient</u>
Concrete	.03-.05	.4-.6
Hard Turf	.05	.4
Firm and Dry Dirt	.04	.3
Soft Turf	.07	--
Wet Concrete	.05	.3
Wet Grass	.10	.2
Snow or Ice	.02	.07-.10

Table 7.3. Approximate Armor Density for Various Materials and Ballistic Protection Levels

Protection (mm)	Material Density (lb/ft ²)	
	Titanium	Kevlar
23	10	3.2
14.7	8.2	2.6
10	6.0	1.9

Table 7.4. Vertical Stabilizer Volume Coefficient (VSVC) Values for Various Fighter Aircraft

Aircraft	Vertical Stabilizer Volume Coefficient
F-4E	.074
F-5A	.116
F-14	.110
F-15	.073
F-16	.102
F-18	.099
A-4C	.122
A-6A	.067
A-7A	.089
A-10	.092
Value Range = .06-.12	

Table 7.5. Typical Values of Surface Roughness (ESR)

Surface Type	Equivalent Sand Roughness (ESR) (inches)
Aerodynamically Smooth	0
Polished Metal or Wood	.02-.08 x 10 ⁻³
Natural Sheet Metal	.16 x 10 ⁻³
Smooth Matte Paint (carefully applied)	.25 x 10 ⁻³
Standard Camouflage Paint (average application)	.40 x 10 ⁻³
Camouflage Paint, Mass Production Spray	1.20 x 10 ⁻³
Dip-Galvanized Metal Surface	6 x 10 ⁻³
Natural Surface of Cast Iron	10 x 10 ⁻³

B. Figures

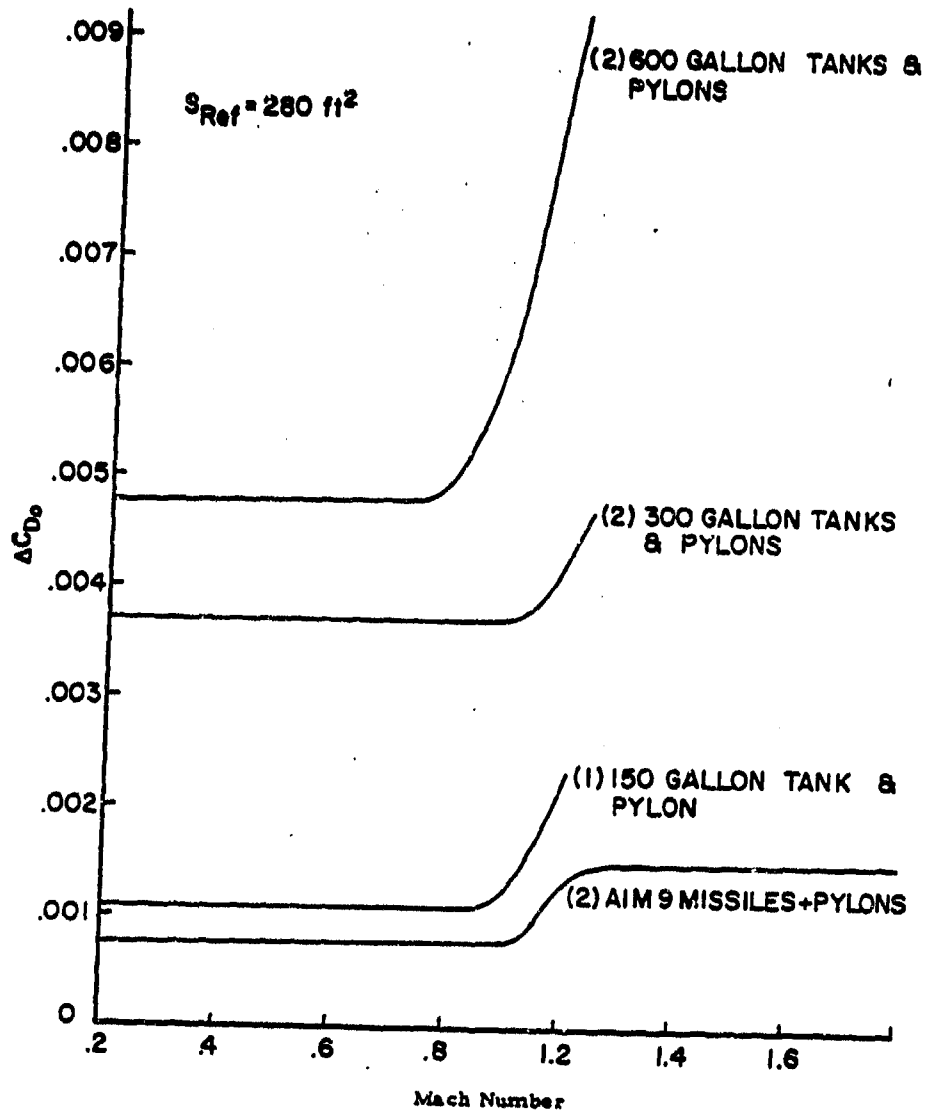

Source: Reference 1.

Figure 7.1. Incremental Drag for External Stores

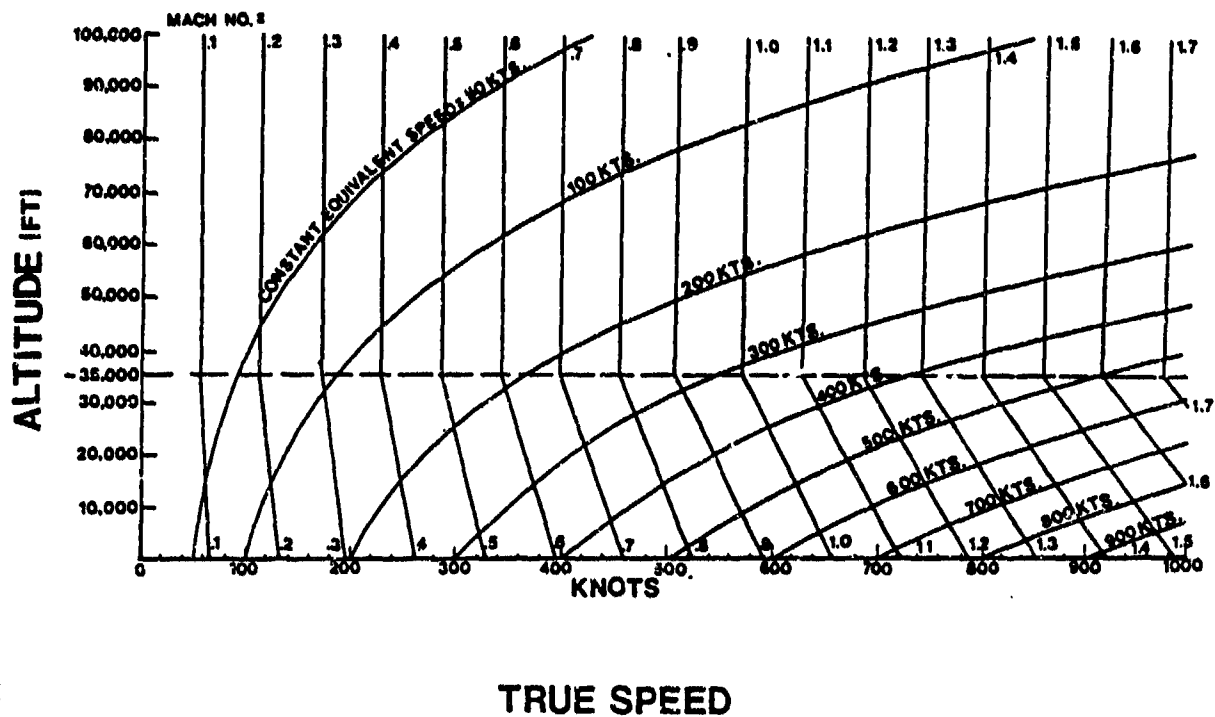

Source: Reference 10.

Figure 7.2. Equivalent Airspeed and Mach Number Versus True Airspeed and Altitude for Standard Atmosphere

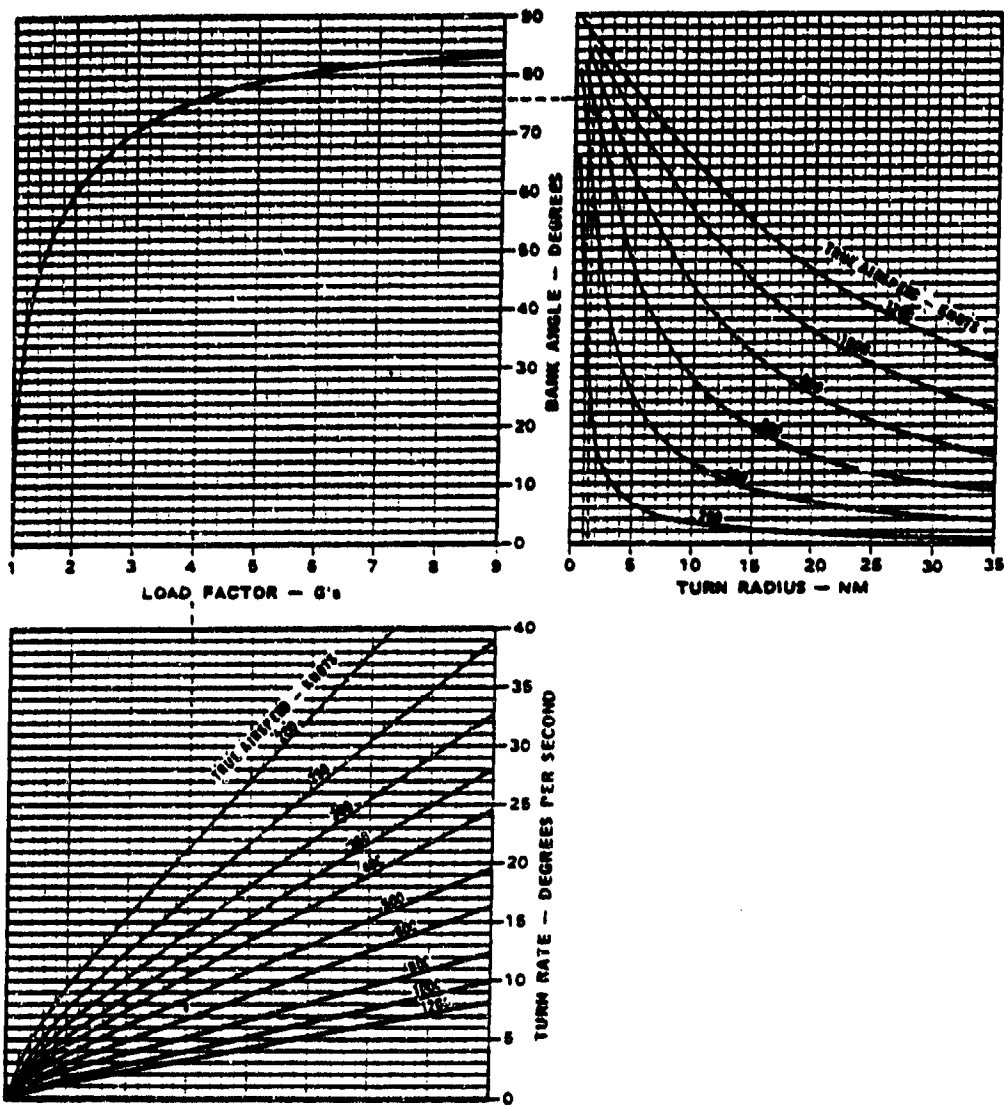

Note: Constant altitude, steady turn.

Figure 7.3. Turn Conversion Chart

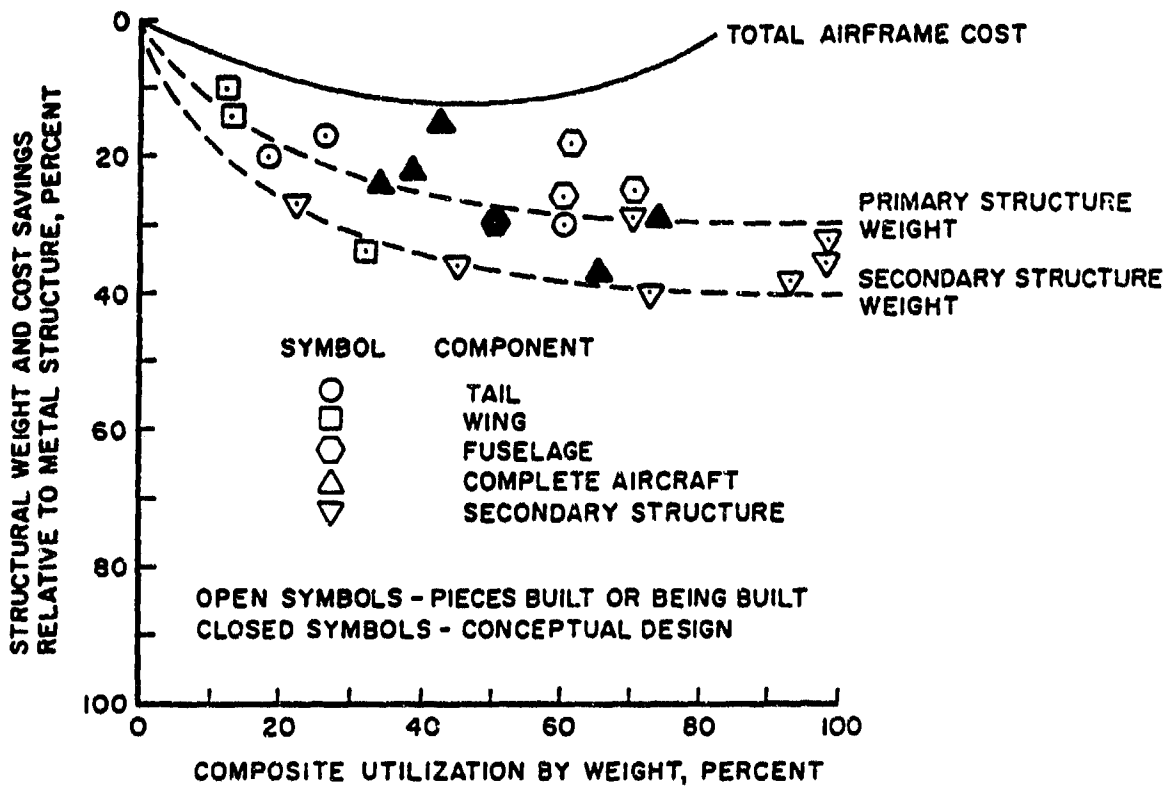

Source: Reference 1.

Figure 7.4. Approximate Weight Savings From Composite Development Programs

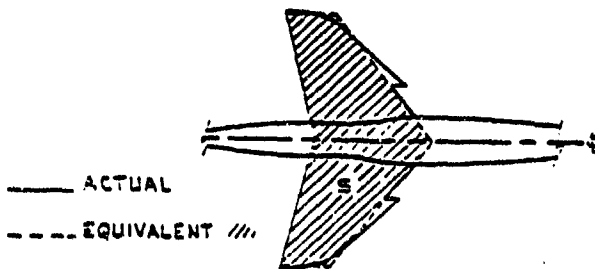
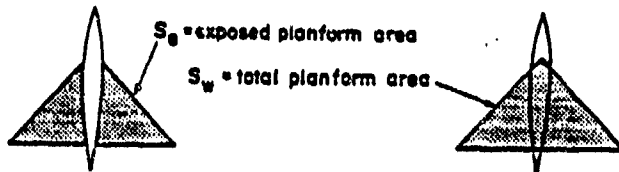
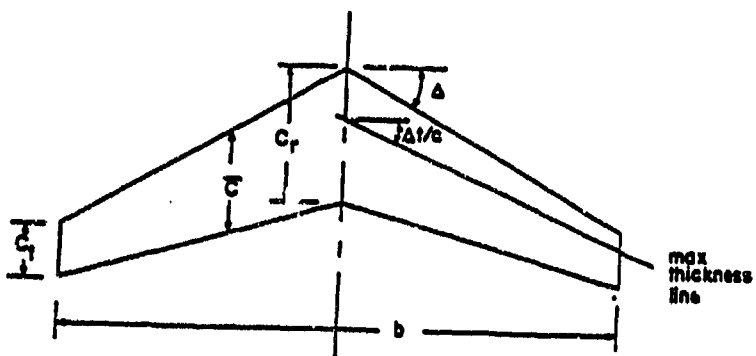

$$\text{SPAN} = b$$

$$\text{LAMD A} = \frac{CT}{CR}$$

$$\text{SWEEP} = \Delta t/c$$

$$\text{SWEEPLE} = \Delta$$

$$\text{WMAC} = \bar{C}$$

$$\text{AR} = \frac{b^2}{S_w}$$

Figure 7.5 Wing Planform Parameters

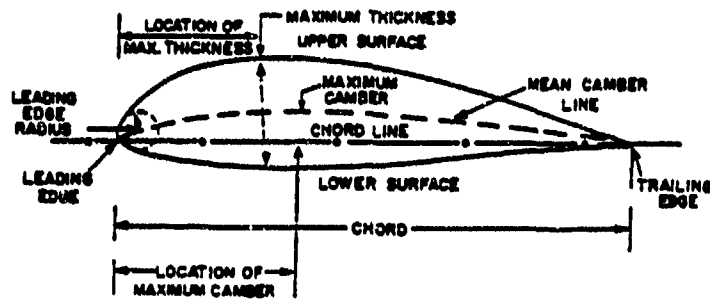
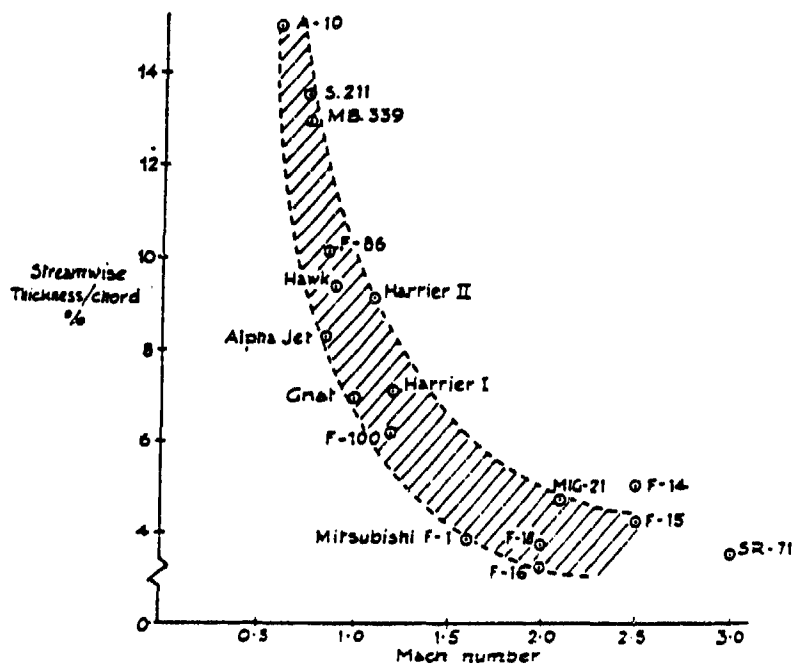
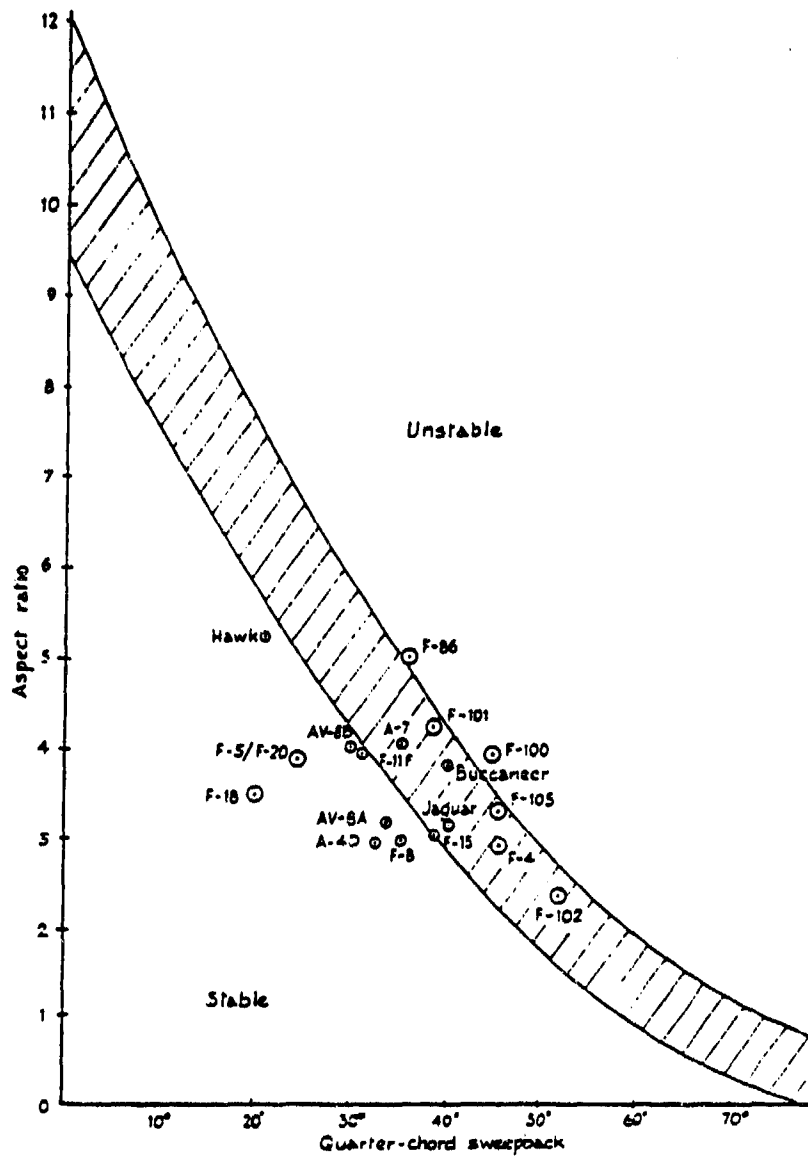

Figure 7.6. Wing Section Parameters



Source: Reference 9.

Figure 7.7. Wing Thickness Versus Maximum Mach Number for Various Aircraft



Source: Reference 9.

Figure 7.8. Aspect Ratio Versus SWEEP for Various Current Aircraft

Canard Configuration:

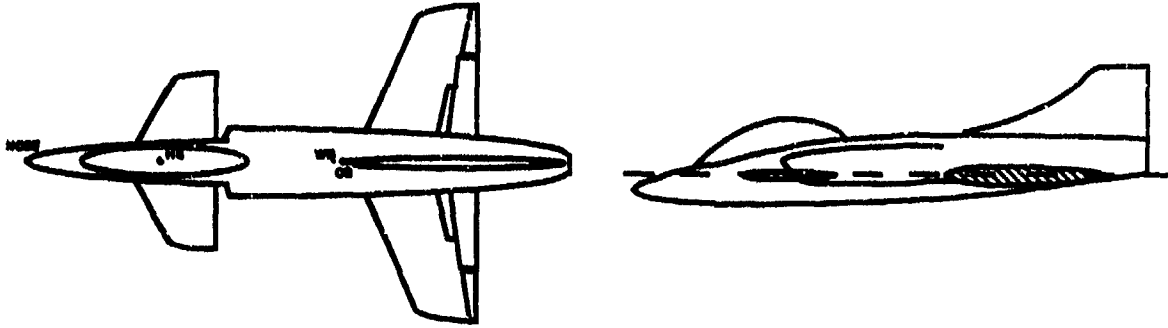

Conventional Configuration:

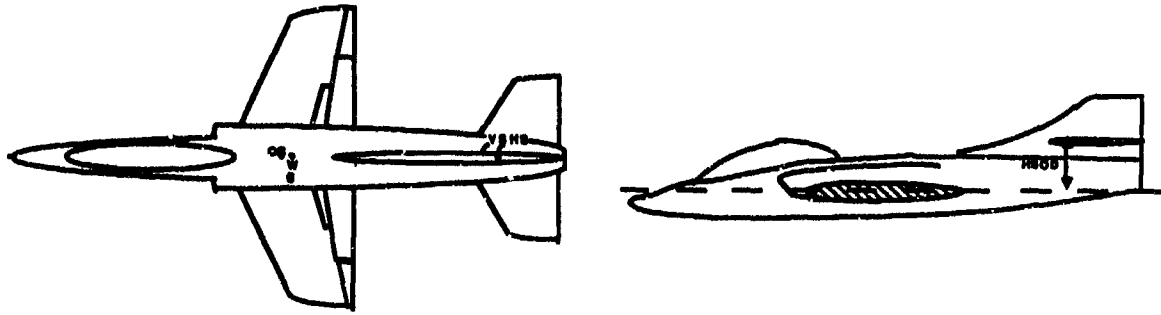

Name	Description	Canard	Conventional
NWB/FL	Nose to wing-body aerodynamic center distance divided by fuselage length.	.55-.60	.45-.55
NCG/FL	Nose to center of gravity distance divided by fuselage length.	.50-.60	.45-.55
HSOD	Horizontal Stabilizer Offset Distance	(-)1.0-3	(-)1.0-3
NVS/FL	Nose to vertical stabilizer distance divided by fuselage length.	.85-.95	.85-.95
NHS/FL	Nose to horizontal stabilizer distance divided by fuselage length.	.15-.35	.85-.95

Figure 7.9. Typical Non-Dimensionalized Vertical/Horizontal Stabilizer, Wing-Body Aerodynamic Center, and Center of Gravity Locations

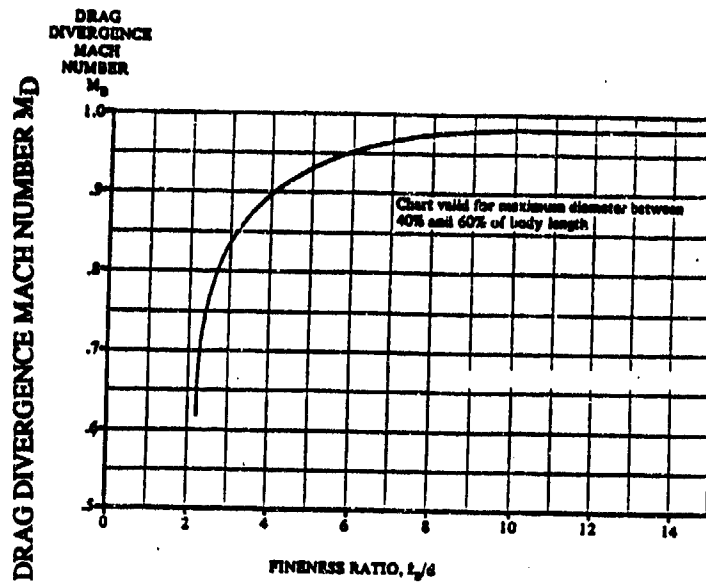

SUBSONIC BEHAVIOR

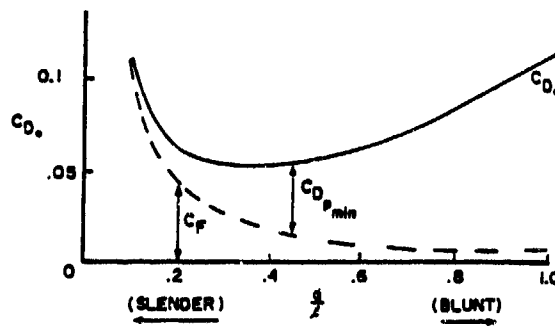

SUPERSONIC BEHAVIOR

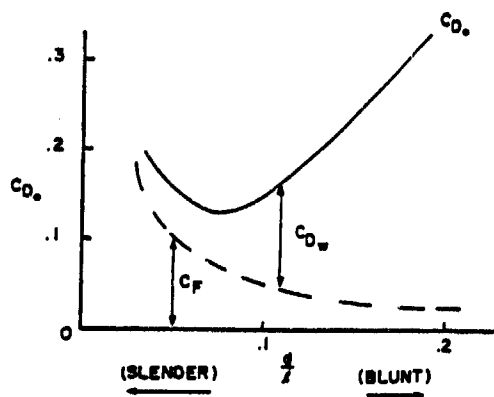
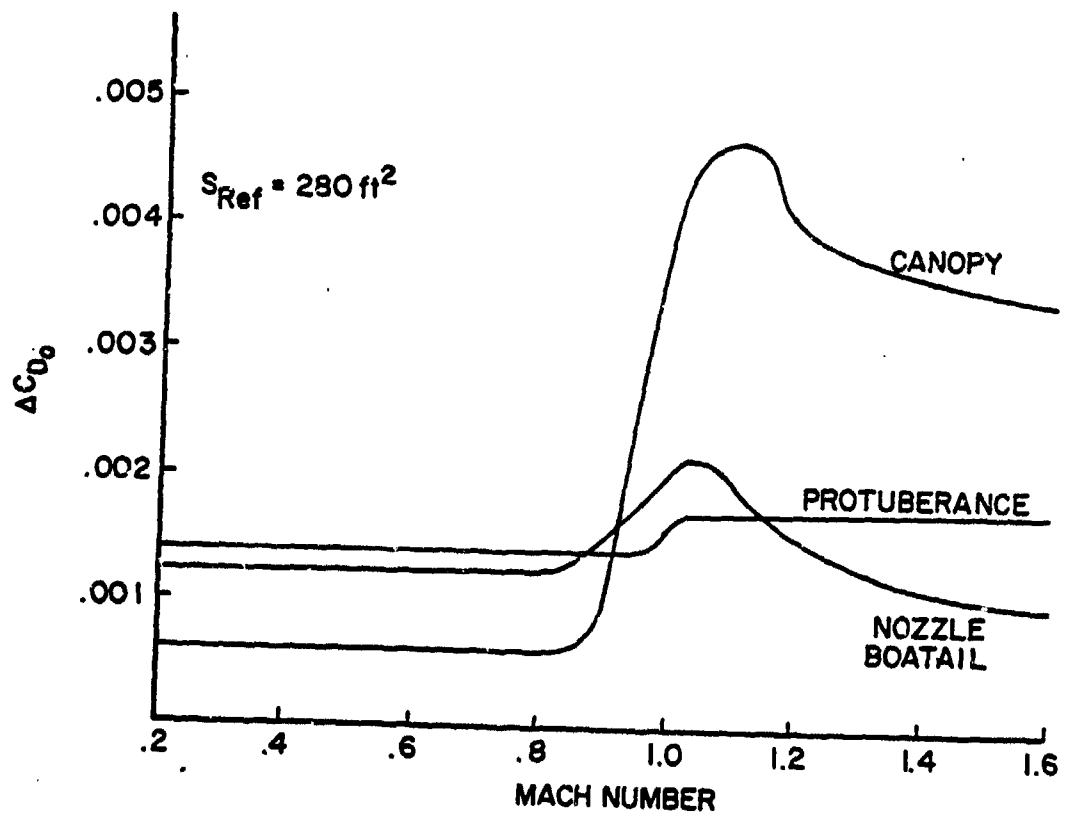
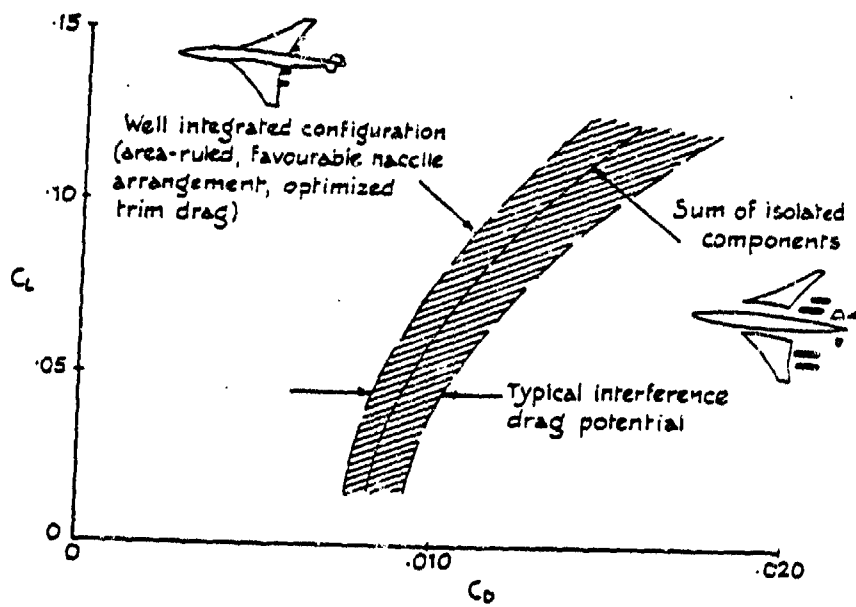

Figure 7.10. Drag Characteristics for Bodies of Revolution (Fuselage)



Source: Reference 1.

Figure 7.11. Sample Incremental Drag for Miscellaneous Items



Source: Reference 9.

Figure 7.12. Influence of Aerodynamic Interference

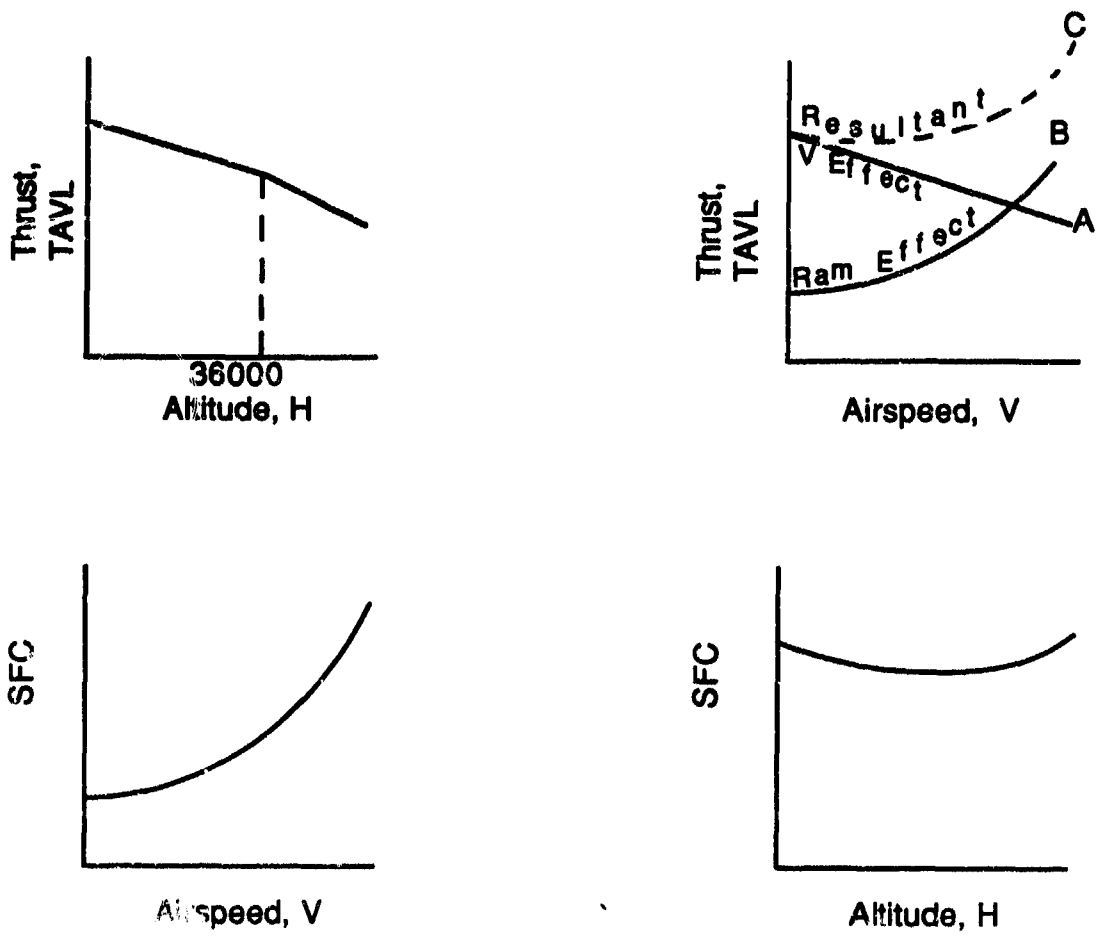

Figure 7-13. Thrust and SFC Trends with Airspeed and Altitude

7.2 FADS Assumptions

- Straight wing leading edges (no cranked arrow).
- Zero base drag from fuselage (closed body).
- Transonic drag from fuselage neglected (fuselage fineness ratio must be greater than 6).
- Wing, horizontal & vertical stabilizer have same T-C; wing & horizontal stabilizer have same sweep.
- No in-air refueling allowance in generic mission profile.
- Structural factor of safety = 1.5 for manned, 1.2 for unmanned aircraft.
- JP-4 fuel (6.5 lb/gallon) or JP-5 (7.1 lb/gallon) used.
- Wing & horizontal stabilizer incidence at takeoff and landing = 0.
- Takeoff rotation and landing free roll time = 3 seconds.
- No asymmetric thrust (thrust vectoring).
- No input flight altitude (H-xxx) greater than the highest engine data altitude (ALTxx) input.
- Range of T-C = 3% to 18% of chord.
- Zero wing twist.
- Thrust loading range = .2 - 1.2.
- No input flight Mach number (velocity) greater than $M = .95$.
- No input flight altitude higher than 60,000 feet.
- No delta wing planforms.
- Fuselage mounted engines (in fuselage).
- Zero trim drag.
- Average 6-series airfoil characteristics used.
- Level, circular turns.
- Single-slotted trailing edge flaps used as trailing edge high lift device.
- Leading edge slats used as leading edge high lift device.
- Fuel fraction for start of engines, taxi, take-off and climb-out is based on 9 minutes at idle, plus one minute at maximum thrust for a total ground time of ten minutes.

7.3 Improvements For FADS

The major consideration throughout the development of the Fighter Aircraft Design System was usability. The aim was to create a model that would generate the desired objectives at a sufficient level of accuracy and applicability with the minimum of input data. In light of this, the Lotus 1-2-3 spreadsheet format was chosen. There are a number of advantages in using the Lotus 1-2-3 spreadsheets for this application. Some of these are:

- Simple Input Data Entry
- Understandable Output Data
- Menu-driven Software
- Rapid Tradeoff Studies.

However, there are inherent problems with the spreadsheet format and specifically, Lotus 1-2-3. For example, by using a PC rather than a mainframe computer, there are memory constraints and much longer program running times. In Lotus 1-2-3, table interpolation is time and memory intensive since there is no routine or function in Lotus to accomplish this. Also, the limit in the length of cell equations hampers the program efficiency. These and other factors can't be avoided since they are indigenous to the spreadsheet method.

Nevertheless, there are many conceivable improvements to FADS that are worthwhile. They will be added by the author as time permits. These improvements fall under 3 categories:

1. Additional Macros--To simplify the use of FADS.
2. Theoretical Improvements--To increase model accuracy.
3. Input Expansion--To increase applicability of FADS.

Additional Macros

The models that comprise FADS currently include a few macros that assist the user to operate them. Additional macros to save the user time are planned. Since tradeoffs and comparisons between different designs are necessary, a macro that automatically runs and saves these designs would be helpful. A macro that retrieves tabulated SFC data from an engine spreadsheet would be a time saver for tradeoffs with different types of engines. Another macro that would be very useful would investigate trades within a design and produce appropriate carpet plots.

Theoretical Improvements

There are many instances within FADS that certain assumptions and approximations are used. An example of this is the aircraft drag buildup within FSM and RPM. The subsonic case a simple parabolic drag polar is assumed. However, in reality, at a particular coefficient of lift called the "break CL" (CL_b), the drag polar ceases to be parabolic and the drag increases considerably. Also in the drag buildup, only the wing wave drag is added for the transonic flight regime. Therefore, the drag calculation is slightly optimistic.

It is advantageous to pursue all the possible improvements to increase the theoretical accuracy of FADS. This includes the example mentioned above and many other improvements. As with the addition of new macros, these modifications will be added as time permits.

Input Expansion

Currently, FADS is only suitable for fighter-type tactical aircraft. This restriction places limits on the input values in the models. There are also constraints on these values due to the input capability of the models. Improvements in these two areas would greatly increase the applicability of FADS.

Many types of aircraft, such as long-range bombers and transports cannot be analyzed with FADS. With sufficient data, a logical scheme can be developed to differentiate the different types of aircraft and systematically derive the required characteristics. Additional inputs and an expanded output section, particularly the empty weight section, would be required. Thus, FADS could be expanded to include the conceptual design of larger and smaller (RPVs) aircraft.

Another way to increase the applicability of FADS would be to increase input capacity. For example, having more altitudes of engine SFC data would accommodate a larger spectrum of possible flight altitudes. A spinoff of this would be an increased level of model accuracy. In addition, including supersonic aerodynamics in the models would allow velocities above the speed of sound in the mission profile inputs and thus increase the point design possibilities within the flight envelope. Providing such an expanded flight envelope in which to place the design points would make FADS more applicable.

8. OVERVIEW OF COMBAT AIRCRAFT DESIGN

8.1 Introduction

Historically, the impetus for the development of combat aircraft has been based on many factors. These include:

- **Current Operational aircraft Deficiencies--low reliability, low range, high fuel consumption.**
- **Changing Threat Systems and Tactics--introduction of new sophisticated weapons or tactics that alter the probability of mission success.**
- **Emergence of New Technology--aerodynamic improvements, material advances, avionics improvements.**
- **National Need--perceived future needs such as the X-30 Aero-Space Plane.**

However, regardless of the impetus, the main considerations that determine the eventual design of new aircraft are performance and cost. The operational effectiveness is driven by the performance of the aircraft. When the cost is also considered, the cost-effectiveness of the aircraft is obtained.

The performance of a combat aircraft can be characterized by a number of distinct attributes. These attributes are categories by which performance can be measured. The six principle attributes are:

1. **Operational Envelope --a measure of static flight capability**
2. **Maneuverability/Agility--a measure of dynamic flight capability**
3. **Lethality--a measure of the destructive capability**
4. **Survivability--a measure of the perserverence capability**
5. **Pilot/Aircraft Interface--a measure of a pilot's ability to use the aircraft**
6. **Supportability--a measure of the sustainability of the aircraft.**

Each attribute is determined by a subset of parameters. For instance, Supportability is determined by many factors, such as reliability, maintainability, and availability. The static flight capability (Operating Envelope) is determined by the aircraft altitude, speed, range, and endurance/persistence ability. For the dynamic flight capability (Maneuverability/Agility), factors such as acceleration potential, rate of climb, rate of turn,

and take-off and landing distances come into play. In addition, the Pilot/Aircraft interface is composed of the handling qualities, visibilities, pilot workload, and overall ergonomics of the cockpit.

Specific aircraft characteristics form the basis of the above subset of the attributes. For example, range (Operating Envelope) is a function of the capacity, lift to drag ratio, and specific fuel consumption. Similarly, wing loading (aircraft weight/wing area) and thrust loading (thrust to weight ratio) play a role in determining many of the static and dynamic flight capabilities--such as turn rates, rates of climb, take-off and landing distances. Also, the payload carried and the target acquisition system are incorporated within weapon systems capability (Lethality).

Unfortunately, attribute subset parameters require different aircraft configurational characteristics, such as thrust loading (thrust to weight ratio). For high turn rates and accelerations (Maneuverability/Agility), a high thrust to weight ratio is desirable. However, if this characteristic is too large, the cruise and loiter specific fuel consumption may be too high. Thus, the range and endurance (Operating Envelope) suffers. This is demonstrated in Figure 8.1. Therefore, tradeoffs must be made with the attributes.

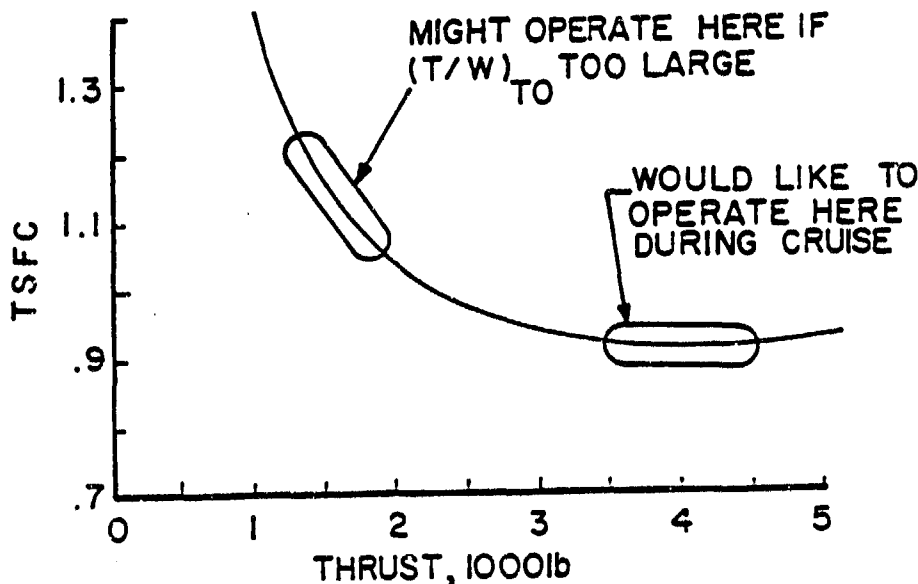

Figure 8.1. Engine Thrust Versus Thrust Specific Fuel Consumption

Tradeoffs must be made even within a certain attribute. This interaction is apparent with Maneuverability/Agility. For an acceleration dominated fighter, such as an interceptor, a high wing loading is desirable. This is because during a minimum time trajectory (an acceleration) the load factor (lift/weight) is close to one. However, for an air-

to-air fighter, the turning capability is critical and thus dictates a low wing loading. In this case the load factor is greater than one.

The mission requirements are the most important drivers in the design of combat aircraft. A key part of these requirements is the design mission profile. Example mission profiles are shown in Figure 8.2. The mission requirements determine the specific configurational characteristics which in turn determine the level of the aircraft attributes. This process yields a hierarchical breakdown of terms that is shown in Figure 8.3.

Formulating the mission requirements is not an easy task. It is often quite difficult to predict what will be needed or desired in the future. For combat aircraft, this is established by the particular military service that will use them. Multi-mission aircraft--aircraft able to perform a variety of missions--are sometimes appealing. These robust aircraft are sized for their most demanding mission, and are thus over designed for the other missions. Specialized aircraft offer less versatility but would be less expensive and more effective in their design mission. In addition to the mission requirements, specific military specifications must also be met.

8.2 Phases Of Design

The general process of aircraft design entails the combination of requirements, concepts, evaluation, and compromise. This iterative process is displayed in Figure 8.4. Due to the complexity involved with designing a new aircraft, the process can be broken down into three distinct levels as follows:

- Conceptual Design
- Preliminary Design
- Detail Design.

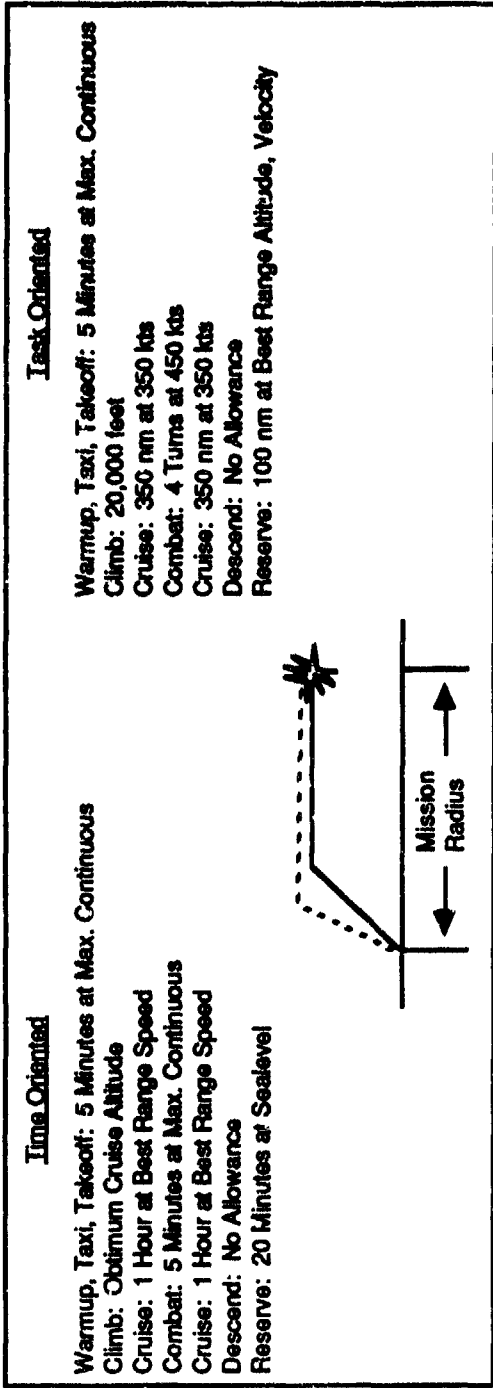

Figure 8.2. Sample Mission Profiles

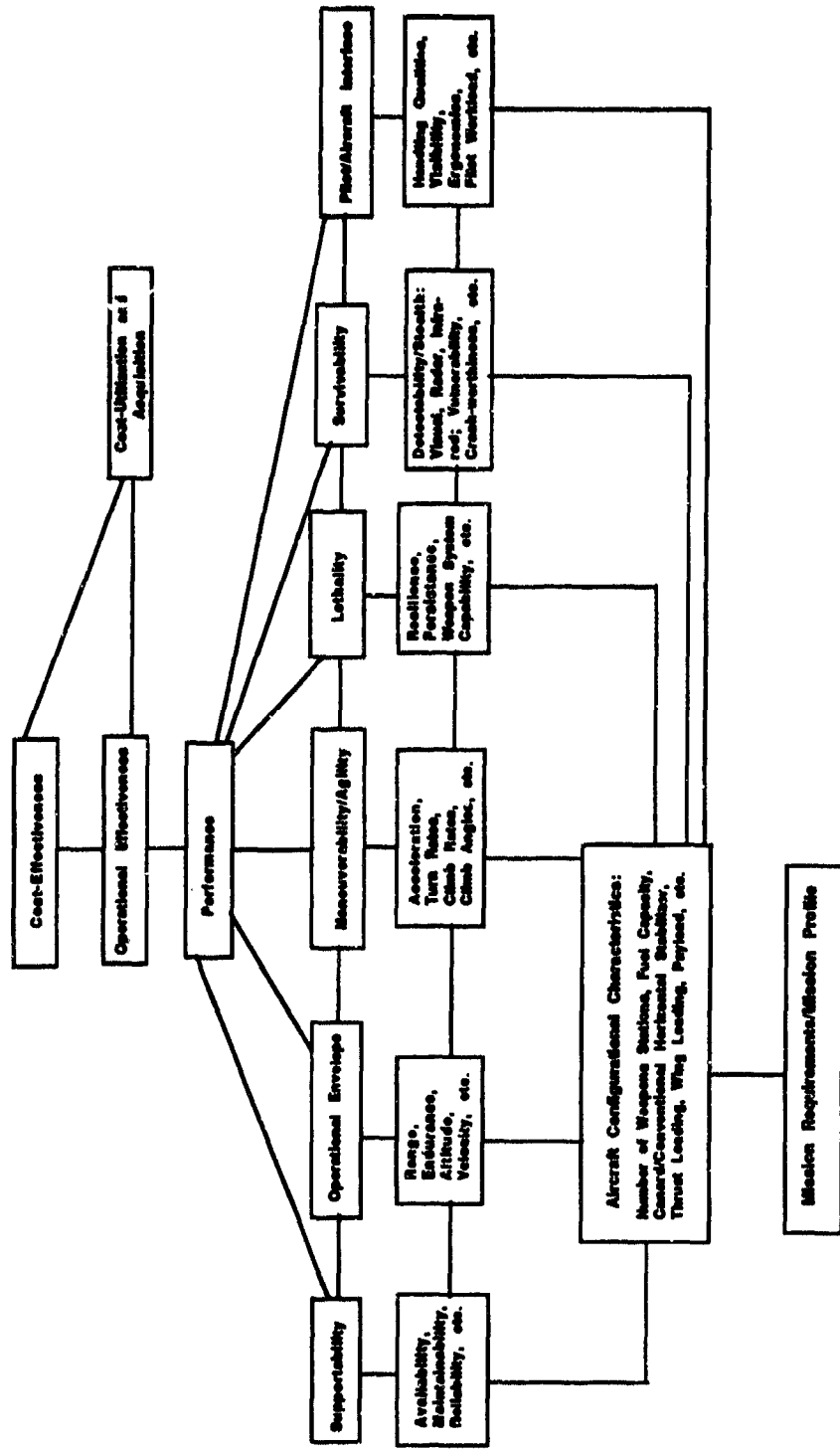

Figure 8.3. Hierarchy of Parameters

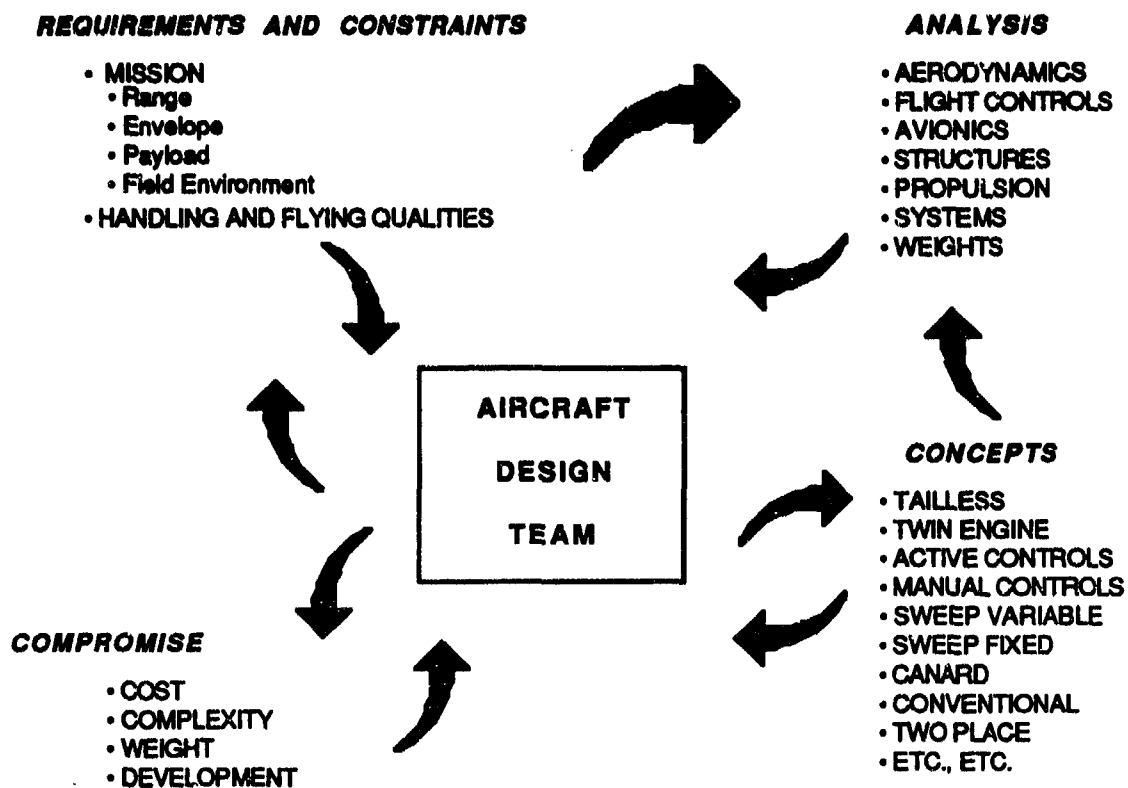

Figure 8.4. Process of Aircraft Design

Some of the inputs to and outputs from each phase are shown in Figure 8.5. The first two phases are sometimes lumped together and called configuration development. While there are no clear cut lines separating the three phases, they do possess certain distinguishable features.

In the conceptual design phase, the size, volume, and shape of the aircraft are determined to see whether the idea is feasible. In addition, the propulsion system is selected. Gross assumptions are needed in this phase. During the conceptual design phase, parametric studies are done to optimize the aircraft configurational characteristics such as airfoil section, planform shape, engine size, fuselage shape. To do this, it is necessary to reach an appropriate compromise between the conflicting mission requirements. While it is important to focus on the dominant mission phases, analyzing the entire mission is essential to achieve an overall satisfactory solution.

These conceptual studies are focused to maximize the performance for a given aircraft design or to optimize the design given the aircraft performance. Cost of the aircraft is also a major consideration. There are a number of parametric design methods that are employed to accomplish the conceptual studies. The baseline method shown in Figure 8.6 is generally used for concept definition and features the following techniques:

- Baseline Analysis
- Parametric Design Derivatives
- Sensitivity Studies.

In the preliminary design phase the aircraft configuration is fine tuned by more extensive and thorough analysis. The internal arrangement is determined and the major loads, stresses, and deflections that the aircraft will encounter are determined. Mock-ups are used in this phase to help visualize and analyze the design. The propulsion system (engine type, inlets, etc.) is finalized. Simulator studies are often done in this phase to analyze the control system and assess the subsequent handling qualities.

The third and final stage of the aircraft design process is the detail design phase. In this phase, the aircraft detail components such as the joints, fittings, fasteners are designed. The interior layout is fixed and component fabrication for the prototype is initiated.

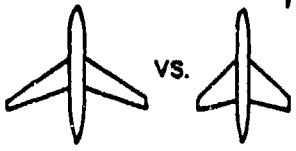
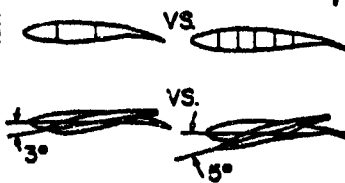
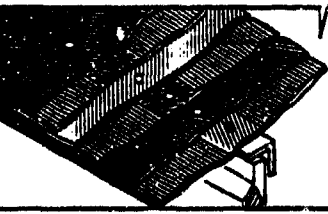
	PHASE I CONCEPTUAL DESIGN	PHASE II PRELIMINARY DESIGN	PHASE III DETAIL DESIGN		
					
KNOWN	<ul style="list-style-type: none"> • BASIC MISSION REQMTS. • RANGE • ALTITUDE • SPEED • BASIC MATERIAL PROPERTIES σ/p E/p q/LB	<ul style="list-style-type: none"> • AEROELASTIC REQMTS. • FATIGUE REQUIREMENTS • FLUTTER REQUIREMENTS • OVERALL STRENGTH REQMTS. 	<ul style="list-style-type: none"> • LOCAL STRENGTH REQUIREMENTS • PRODUCIBILITY • FUNCTIONAL REQMTS. 		
RESULTS	<table border="1"> <tr> <td> GEOMETRY • AIRFOIL TYPE • R • t/c • λ • Δ </td> <td> DESIGN OBJECTIVES • DRAG LEVEL • WEIGHT GOALS • COST GOALS </td> </tr> </table>	GEOMETRY • AIRFOIL TYPE • R • t/c • λ • Δ	DESIGN OBJECTIVES • DRAG LEVEL • WEIGHT GOALS • COST GOALS	<ul style="list-style-type: none"> • BASIC INTERNAL ARRGMT. • COMPLETE EXTERNAL CONFIG. • CAMBER, TWIST DISTRIBUTIONS • LOCAL FLOW PROBLEMS SOLVED • MAJOR LOADS, STRESSES, DEFLECTIONS 	<ul style="list-style-type: none"> • DETAIL DESIGN • MECHANISMS • JOINTS, FITTING, & ATTACHMENTS • DESIGN REFINEMENTS AS RESULTS OF TEST & OPER.
GEOMETRY • AIRFOIL TYPE • R • t/c • λ • Δ	DESIGN OBJECTIVES • DRAG LEVEL • WEIGHT GOALS • COST GOALS				

Source: Reference 1.

Figure 8.5. The Three Phases or Levels of Aircraft Design

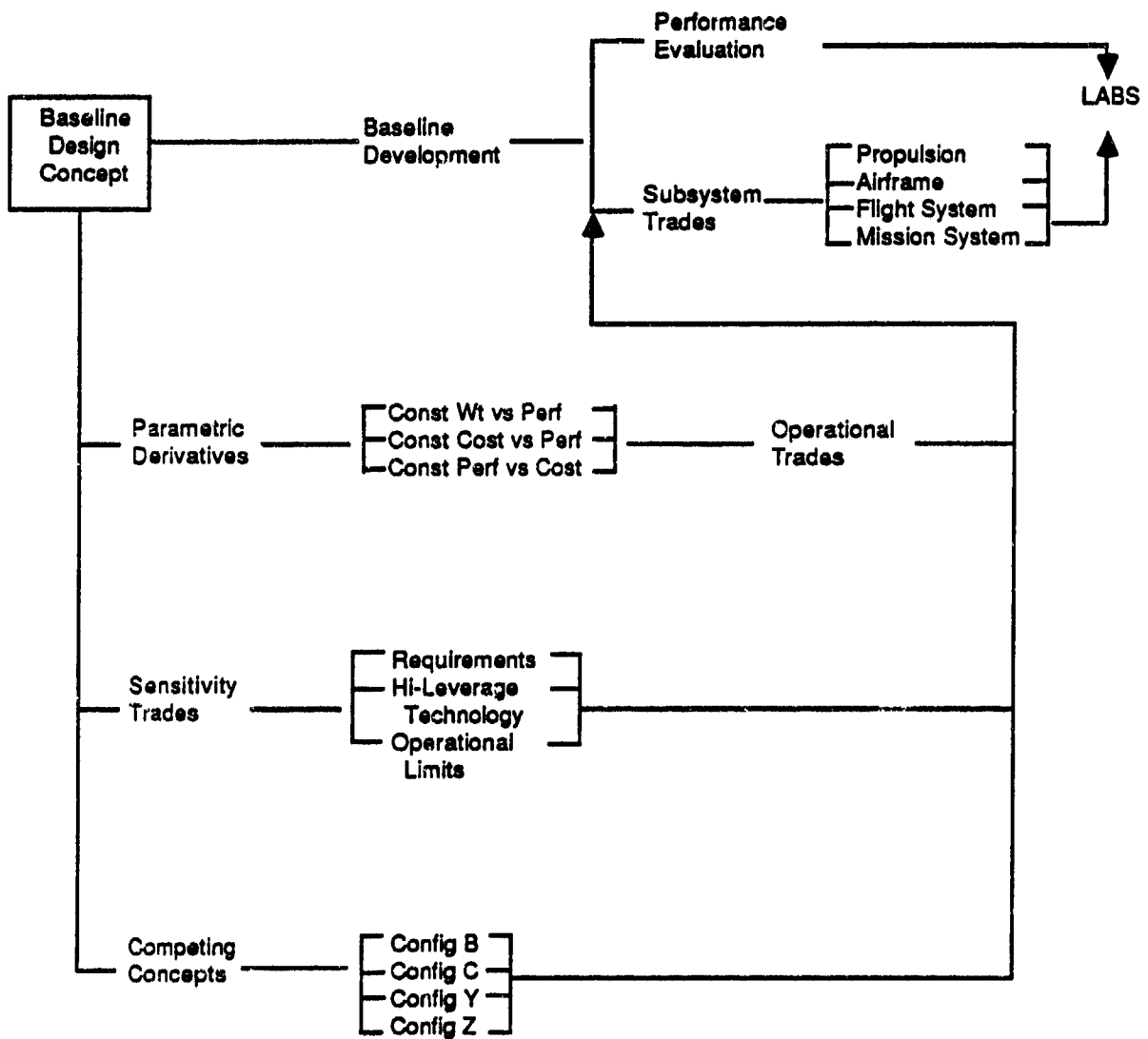

Source: Reference 7.

Figure 8.6. The Baseline Method for Trade Studies

If the prototype proves to be successful and desirable, production of the aircraft ensues. The elapsed time scale from initial conception to production has grown enormously over the years. This process used to take a few years, now, ten years or more is typical.

8.3 Classification Of Combat Aircraft

The design mission profile yields a distinction between combat aircraft that can be used as a classification scheme. Military specification number MIL-F-8785B places all aircraft into four classes. This is shown in Figure 8.7. To further visualize the variation, Figure 8.8 displays the spread of take-off weight and empty weight fractions for a number of current aircraft.

For the fighter-type (tactical) aircraft, there are basically five categories:

- Close Air Support
- Strike Interdiction
- Interceptor
- Air to Air
- High Altitude.

Generally, these aircraft have significantly different attribute subset values. For instance, an interceptor-type fighter is designed to have long range, high speed to operate at high altitude. A close air support aircraft cruises at medium range, medium speed with combat at low altitude.

More specifically, the differences among these aircraft are reflected in their wing loading and thrust loading values. These two parameters, shown in Table 8.1, are very important outputs from the design process. As shown in Figure 8.9, an inverse relationship exists between these parameters.

8.4 Summary

The design of a new combat aircraft is an enormous undertaking. High performance fighter aircraft are complicated systems that require a great deal of time, money, and manpower to produce. Multidisciplinary technology integration is necessary. Aerodynamics, structures, power plants, human factors, electronics, and controls all have to be brought together to form a coherent package. Currently, there are substantial improvements possible in many of these areas. Since technological advances in

Class I	Small, light airplane such as Light utility Primary trainer Light observation
Class II	Medium weight, low-to-medium maneuverability airplanes such as Heavy utility/search and rescue Light or medium transport/cargo/tanker Early warning/electronic countermeasures/ airborne command, control, or communications relay Antisubmarine Assault transport Reconnaissance Tactical bomber Heavy attack Trainer for Class II
Class III	Large, heavy, low-to-medium maneuverability airplanes such as Heavy transport/cargo/tanker Heavy Bomber Patrol/early warning/electronic countermeasures airborne command, control, or communications relay Trainer for Class III
Class IVA	High-maneuverability airplanes such as Fighter/interceptor Attack Tactical reconnaissance Observation Trainer for Class IV
Class IVB	Air-to-air fighter
Class IVC	Air-to-ground fighter with external stores

Figure 8.7 MIL-F-8785B Aircraft Classification Specification

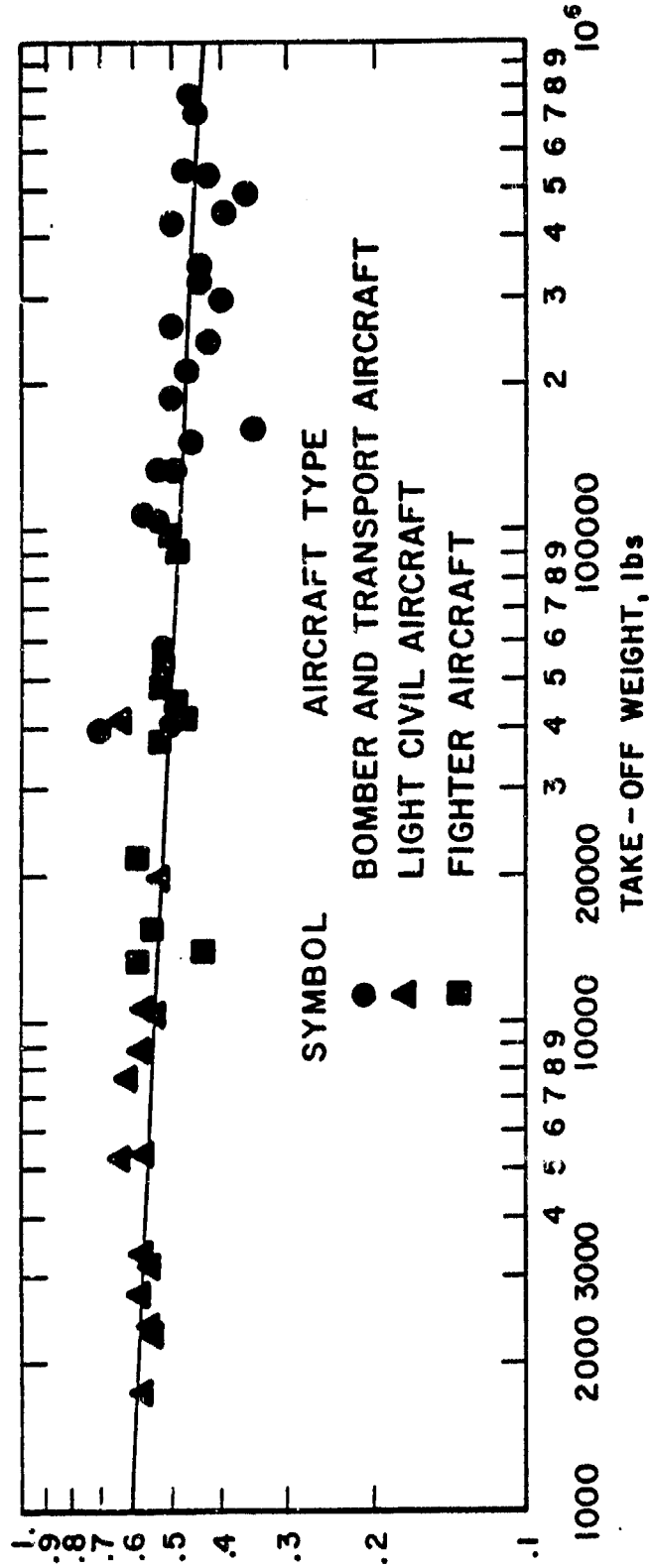

Source: Reference 1.

Figure 8.8. Empty Weight Fraction for Current Aircraft

Table 8.1. Take-Off Wing Loading and Thrust to Weight Trends

Fighter Type	Wing Loading @ Take-Off Range (lb/ft ²)	Thrust Loading @ Take-Off Range (Uninstalled)
Close Air Support	65-90	.4-.6
Strike Interdiction	90-130	.45-.7
Interceptor	120-150	.55-.8
Air to Air	40-70	.8-1.3
High Altitude	30-60	.4-.8

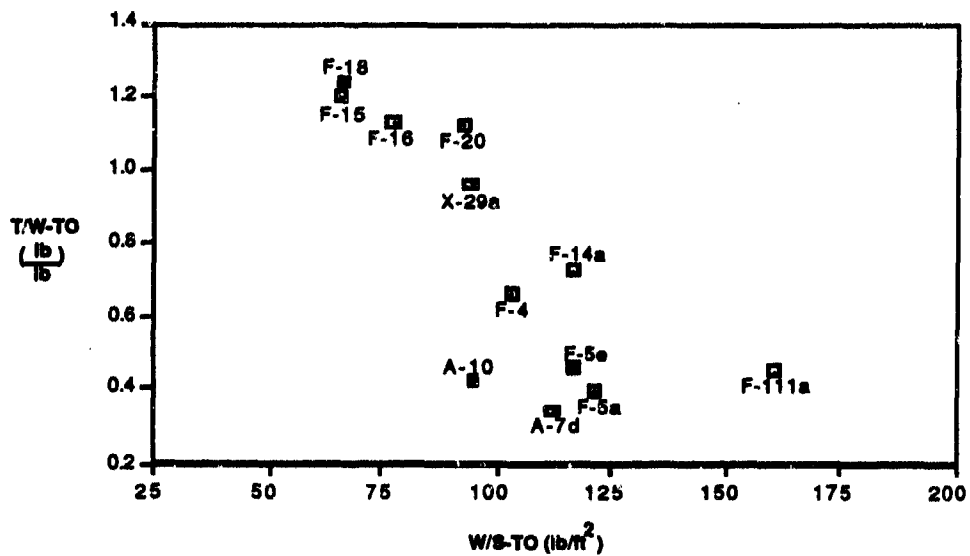

Figure 8.9. Thrust Loading Versus Wing Loading for Current Aircraft

any one of these areas usually has a significant impact on the others, the operational payoffs can be significant.

However, these new technology applications are only a part of the driving force in the development of new combat aircraft. It is often more cost-effective to upgrade existing aircraft with new sub-system components, such as new engines. With the increasing cost of new combat aircraft, this trend seems likely to continue in the near future.

REFERENCES

1. Nicolai, Leland M., *Fundamentals of Aircraft Design*, Aerospace Engineering, University of Dayton, Dayton, Ohio, June 1975.
2. Perkins, Courtland D., and Hage, Robert E., *Airplane Performance Stability and Control*, John Wiley & Sons, Inc., New York, London, Sydney, September 1949.
3. Roskam, Jan, *Methods For Estimating Drag Polars of Subsonic Airplanes*. Published by the Author, 1971. Library of Congress Catalog Card Number: 73-173351.
4. Roskam, Jan, *Methods For Estimating Stability and Control Derivatives of Conventional Subsonic Airplanes*. Published by the Author, 1971. Library of Congress Catalog Card Number: 77-173352.
5. Lan, C. Edward, and Roskam, Jan, *Airplane Aerodynamics and Performance*. Published by Roskam Aviation and Engineering Corporation, Ottawa, Kansas, 1980. Library of Congress Catalog Card Number: 80-6308.
6. Roskam, Jan, *Flight Dynamics of Rigid and Elastic Airplanes*. Published by Roskam Aviation and Engineering Corporation, Lawrence, Kansas, 1972. Library of Congress Catalog Card Number: 79-185121.
7. Notes from: *Aircraft Design Short Course*, University of Dayton, Dayton, Ohio, Summer 1975.
8. Notes from: *Vehicular Performance*, Rensselaer Polytechnic Institute, Spring 1986.
9. Whitford, Ray, *Design For Air Combat, United Kingdom*, Jane's Publishing Company Limited, London, 1987.
10. Heinemann, E., Ravsa, R., Van Every, K.E., *Aircraft Design*, The Nautical and Aviation Publishing Company of America, Inc., 1985.
11. *Aeronautical Research and Technology Policy*, Vol. II (Final Report), Executive Office of the President, Office of Science and Technology Policy, November 1982.
12. *Lifting Capabilities of Wings With and Without High-Lift Devices*, Martin Report, ER 8055.

13. **Augustine, Norman, *Augustine's Laws and Major System Development Programs*, AIAA, NY, NY, 1983.**
14. **Excerpts From Standard Aircraft Characteristics, Aeronautical Systems Division, Wright Patterson Air Force Base, OH.**
15. **ASAP User Manual, Initiation Module-LTV Aircraft Products Group, Military Aircraft Division, Dallas, TX.**
16. ***Aircraft Preliminary Design Methods Used in the Weapons Systems Analysis Division*, NAVWEPS, Report No. R-5-62-13.**
17. ***Cost-Estimating Relationships for Tactical Combat Aircraft*, IDA Memorandum Report M-14, UNCLASSIFIED.**

APPENDIX A

FADS Comparison With Existing Aircraft

In order to substantiate the FADS models, comparisons were done using several existing aircraft. Two of the aircraft used were the LTV A7A Corsair II and the Douglas A-4-C Skyhawk. Although these aircraft were designed over 25 years ago, they are representative of the type of aircraft that can be analyzed with FADS. This demonstrates that while the avionics and materials used in aircraft are continuously changing, the basic aerodynamics used to analyze them remains relatively the same.

The lack of appropriate data and the general format of FADS make it difficult to substantiate FADS. Therefore, it is necessary to look at and validate specific methods used in the models. Thus, if these methods or parts accurately determine the particular parameters, it is assumed that FADS is verified. These specific methods include: the CL-MAX estimation, the empty weight buildup, the profile drag buildup, and the horizontal/vertical stabilizer sizing. Since FSM encompasses the majority of the methodology, it is used exclusively for the comparison.

As previously discussed, the Fighter Aircraft Sizing Model determines the following parameters:

- Take-off Gross Weight (TOGW)
- Operating Weight Empty (OWE)
- Wing Area (SW)
- Thrust Loading at Takeoff (T/W)

To investigate the methodology used in FADS, it is essential to have some of these parameters correspond to the specific aircraft. For instance, the empty weight buildup is a function of the gross weight. In order to measure the accuracy of the empty weight buildup method, the gross weight of the specific aircraft must be used. In addition, the configuration inputs, wing area, thrust loading at takeoff, and vertical and horizontal stabilizer areas must correspond to that aircraft. The resultant empty weight can then be compared to the true empty weight of the aircraft.

The HI-HI-HI mission was chosen for comparison purposes. The aircraft data is from Reference 14. A clean airplane is assumed, eliminating the need to gather precise information regarding the additional drag and interference of external stores. The following are the results of the comparison.

CL-MAX DETERMINATION						
Fixed Parameters: Wing Area (SW)						
Results:	FSM	A7A	% ERROR	FSM	A4C	% ERROR
CL-MAX	1.22	1.12	8.9	1.11	----	----
CL-MAX (flaps)	1.44	1.45	.7	1.47	1.41	4.3
CL-MAX (slats)	1.51	----	----	1.21	----	----

VERTICAL AND HORIZONTAL STABILIZER SIZING						
Fixed Parameters: Wing Area (SW) Thrust Available @ Takeoff (T) Takeoff Gross Weight (TOGW)						
Results:	FSM	A7A	% ERROR	FSM	A4C	% ERROR
Horiz. Stab. Area (ft ²)	50.0	56.4 (exposed)	11.3	37	45 (exposed)	17.8
Vert. Stab. Area (ft ²)	107.1	105.5	1.5	52	55	5.5

PROFILE DRAG (CDO) BUILDUP						
Fixed Parameters: Wing Area (SW) Horizontal/Vertical Stabilizer Areas (SHS/SVS)						
Results:	FSM	A7A	% ERROR	FSM	A4C	% ERROR
Wetted Area (ft ²)	1614	1613	0	1075	1094	1.7
CDo (Includes Interference)	.0156	.0151	3.3	.0157	4.3	4.3

EMPTY WEIGHT BUILDUP						
Fixed Parameters:						
Wing Area (SW)						
Horizontal/Vertical Stabilizer Areas (SHS/SVS)						
Thrust Available @ Takeoff (T)						
Takeoff Gross Weight (TOGW)						
Results:	FSM	A7A	% ERROR	FSM	A4C	% ERROR
OWE Total (lbs)	13384	14706	9.0	7938	9073	12.5
Structure (lbs)	6727	7542	10.8	3878	4396	11.8
Propulsion (lbs)	3696	3855	4.1	2218	2748	19.3
Survivability (lbs)	0	0	--	0	0	--
Miscellaneous (lbs)	2981	3309	10.5	1842	1929	4.5

TAKEOFF AND LANDING						
Fixed Parameters:						
Wing Area (SW)						
Horizontal/Vertical Stabilizer Areas (SHS/SVS)						
Thrust Available @ Takeoff (T)						
Operating Weight Empty (OWE)						
Takeoff Gross Weight (TOGW)						
Profile Drag (CDo)						
Results:	FSM	A7A	% ERROR	FSM	A4C	% ERROR
Takeoff stall velocity (kts)	119	121	1.7	128	114	12.3
Landing stall velocity (kts)	90	93	3.2	107	97	10.3
Takeoff ground roll (ft)	3030	2680	13.9	2288	2300	.5
Landing ground roll (ft)	2170	2490	12.9	2348	2540	7.6

FUELUSED/TAKEOFF GROSS WEIGHT						
Fixed Parameters:						
Wing Area (SW)						
Horizontal/Vertical Stabilizer Areas (SHS/SVS)						
Profile Drag (CDo)						
Operating Weight Empty (OWE)						
Thrust Required						
Results:	FSM	A7A	% ERROR	FSM	A4C	% ERROR
Fuel used (lbs)	10439	10200	2.3	5916	5440	8.8
TOGW (lbs)	25297	25969	2.6	15746	16228	3.0

APPENDIX B

EQUATIONS AND METHODOLOGY USED IN MODELS

A. FIGHTER SIZING MODEL

The methodology for the sizing model is presented in this section. It follows the associated flowchart shown in Figure 3.1. The output parameters are listed with the equations that generate them in the order they are calculated.

Aerodynamics Calculations:

Note that in the output parameters [xxx] represents the phase CR1, DS2, CB, etc., and [xx] represents the aircraft component, F, W, etc. Also, [#] means 1 or 2, corresponding to the loiter phase.

- SWEEPLE--wing sweep at the leading edge.

$$\text{SWEEPLE} = \text{Tan}^{-1} \left[\text{Tan}(\text{SWEEP}) + \frac{1}{\text{AR}} \left(\frac{1-\lambda}{1+\lambda} \right) \right] \quad (1)$$

- SWEEPC2--wing sweep at the half-chord.

$$\text{SWEEPC2} = \text{Tan}^{-1} \left[\text{Tan}(\text{SWEEP}) - \frac{2}{\text{AR}} \left(\frac{1-\lambda}{1+\lambda} \right) \right] \quad (2)$$

NOTE: For arbitrary location wing sweep amount:

$$\text{Tan } \Delta_n = \text{Tan } \Delta_m - \frac{4}{\text{AR}} \left[(n-m) \left(\frac{1-\lambda}{1+\lambda} \right) \right] \quad (3)$$

- SPAN--wing span.

$$\text{SPAN} = \sqrt{\text{AR} \cdot \text{SW}} \quad (4)$$

- CR--wing root chord.

$$\text{CR} = \frac{2 \text{SPAN}}{(1+\lambda) \text{AR}} \quad (5)$$

- CT--wing tip chord.

$$\text{CT} = \text{CR} \cdot \lambda \quad (6)$$

- WMAC--wing mean aerodynamic chord.

$$WMAC = \frac{2}{3} CR \left(\frac{1 + \lambda^2 + \lambda}{1 + \lambda} \right)$$

(7)

- EP--Weisinger Wing Planform efficiency factor (e').

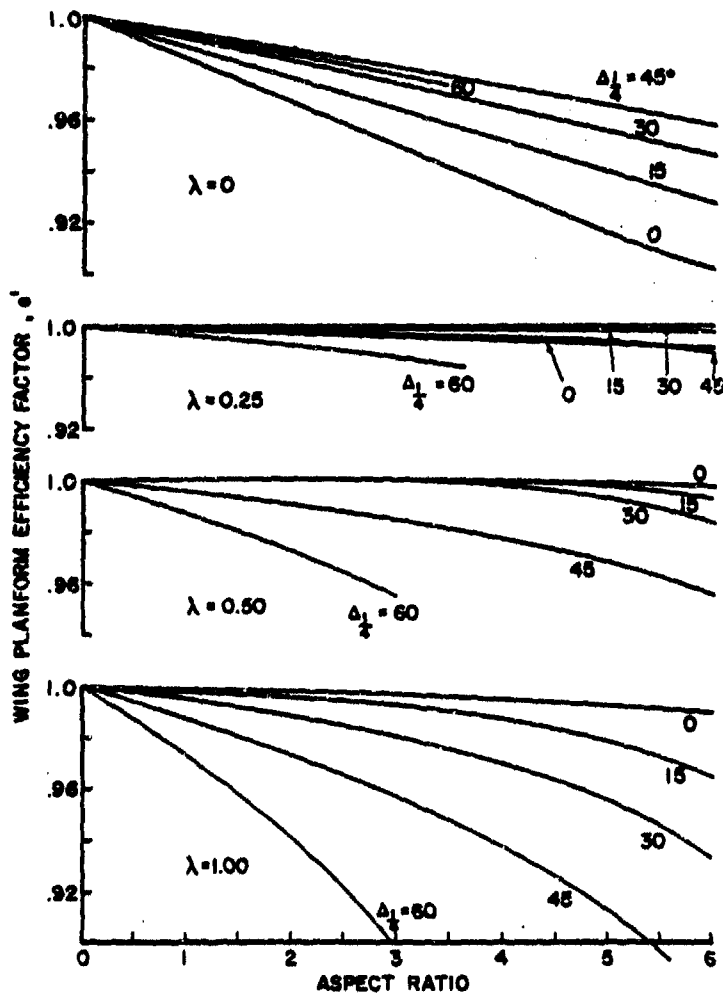

Reference 1

EP= Table lookup with AR, SWEEP, λ

(8)

- E--wing efficiency factor.

$$E = EP \cdot \left(1 - \left(\frac{FD}{SPAN} \right)^2 \right) \quad (9)$$

- KP--induced drag factor.

$$KP = \frac{1}{\Pi \cdot AR \cdot E} \quad (10)$$

- Q-[xxx]--phase dynamic pressures.

$$Q - [xxx] = \frac{\rho - [xxx] \cdot (v - [xxx])^2}{2} \quad (11)$$

- B-[xxx]--phase betas.

$$B - [xxx] = \sqrt{|(MN - [xxx])^2 - 1|} \quad (12)$$

- LER--Leading edge radius divided by the chord.

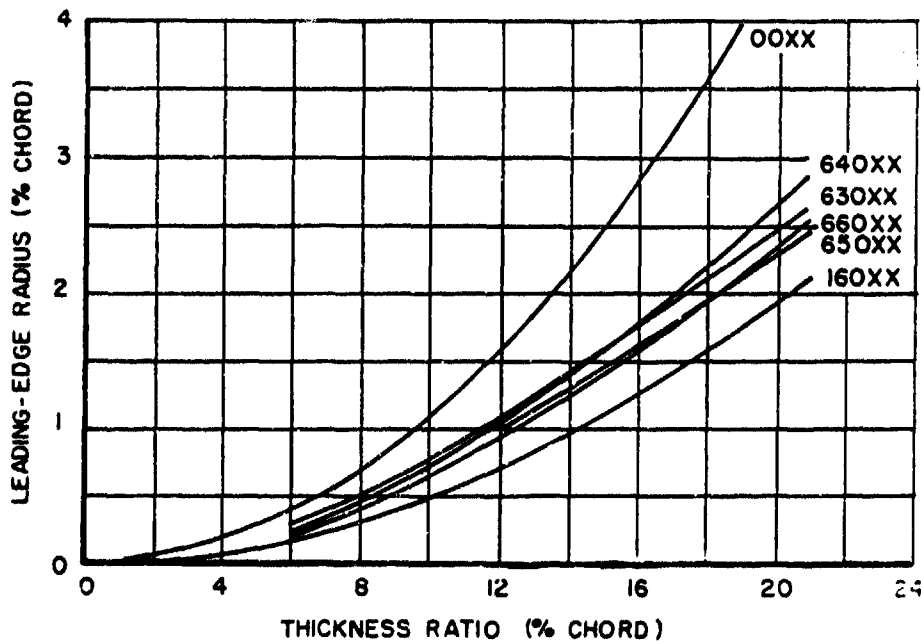

$$\begin{aligned} LER &= .0625 \cdot (T-C) - .00125 & 0 \leq (T-C) & \leq .06 \\ LER &= .125 \cdot (T-C) - .005 & .06 \leq (T-C) & < .12 \\ LER &= .1875 \cdot (T-C) - .0125 & (T-C) \geq .12 & \end{aligned} \quad (13)$$

• KPP--Viscous drag factor.

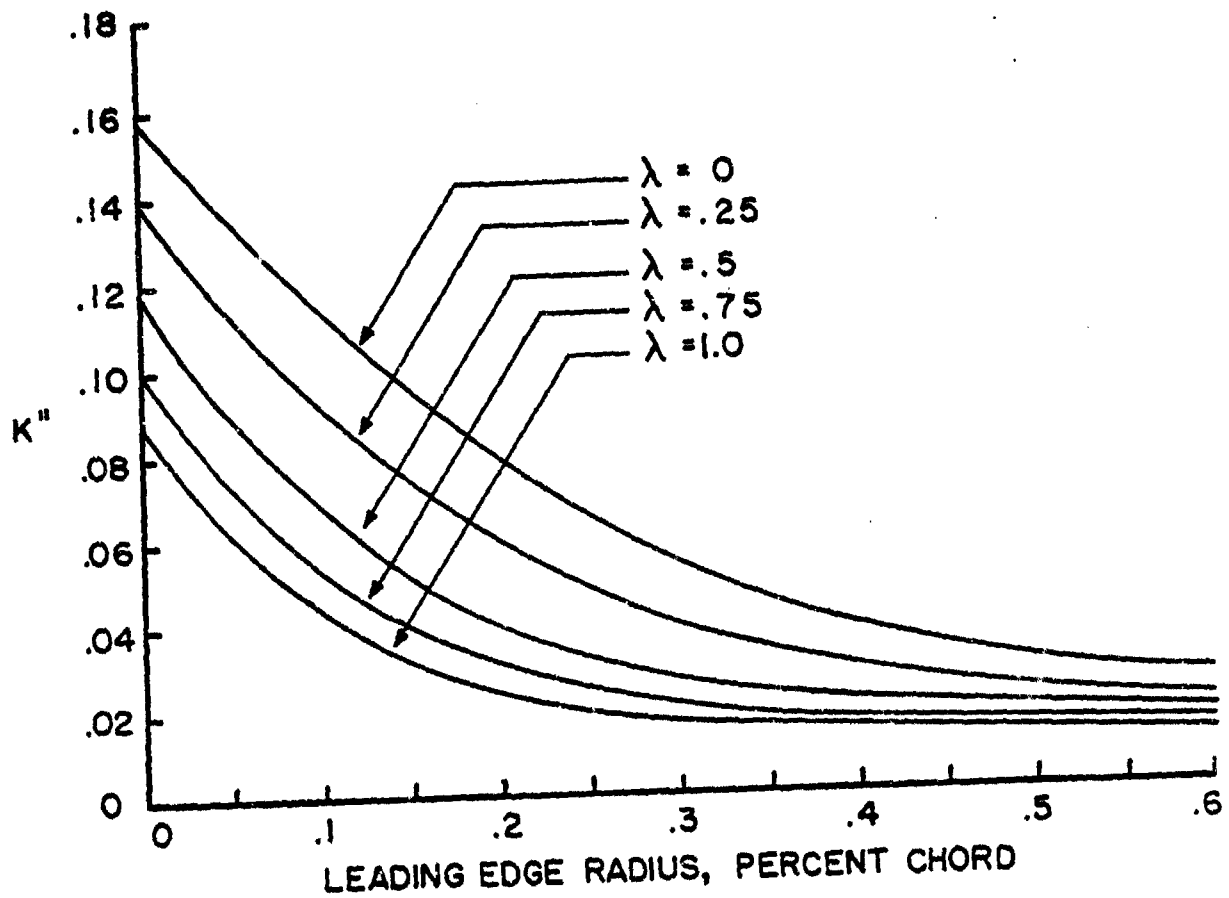

KPP = Table lookup with λ and LER

(14)

- LES--Leading edge sharpness (Δy).

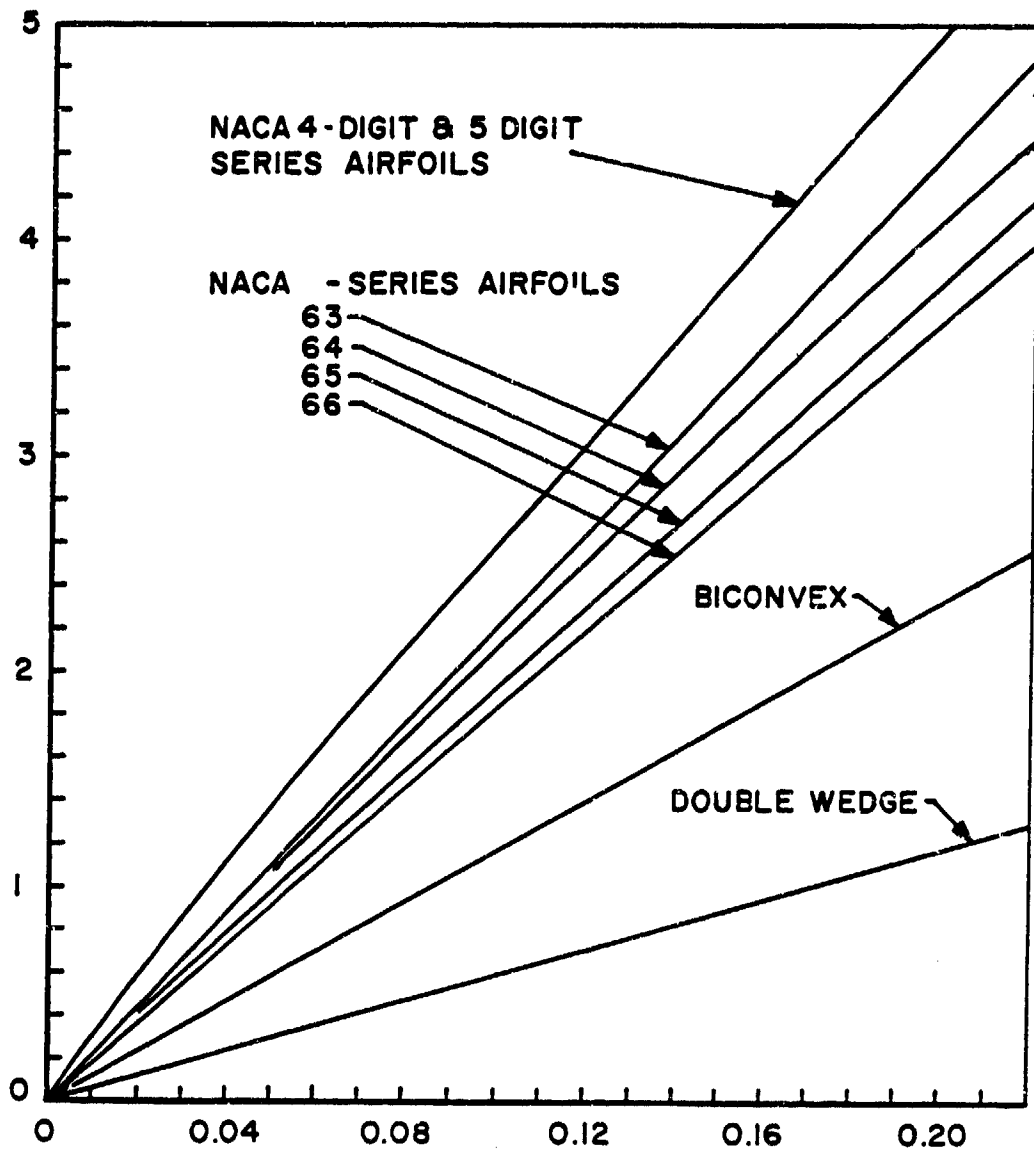
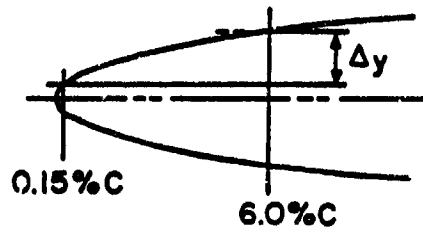

THICKNESS RATIO

$$LES = .2 \cdot (T-C)$$

(15)

The next several outputs in this group involve the determination of the CL-MAX of the wing, wing with flaps, and wing with slats. The methodology used is derived from the Martin Report, ER 8055. The method entails using a baseline 6 series wing with adjustments made due to the variation of wing sweep, thickness, aspect ratio, and flap or slat span. An additional variation of the design lift coefficient was added to compensate for the effect of wing camber.

- CL-MAX[NF/F/S]--Maximum lift coefficient [no flap/flap/slat].

$$\left. \begin{array}{l} \text{CL-MAX NF} = \\ \text{CL-MAX F} = \\ \text{CL-MAX S} = \end{array} \right\} \text{Table lookups with SWEEP, T-C, AR, SSWS, FSWS} \quad (16)$$

- X-MSN--design mission radius.

$$X - \text{MSN} = \frac{(X - \text{CR1}) + (X - \text{CR2})}{2} + \frac{(X - \text{DS1}) + (X - \text{DS2})}{2} \quad (17)$$

The zero-lift, clean aircraft drag coefficient is evaluated at the average cruise phase conditions.

- HBAR--average cruise altitude.

$$\text{HBAR} = \frac{(\text{H-CR1}) + (\text{H-CR2})}{2} \quad (18)$$

- VBAR--average cruise velocity.

$$\text{VBAR} = \frac{(\text{V-CR1}) + (\text{V-CR2})}{2} \quad (19)$$

- VPBAR--velocity at M = 0.6 (for cut-off Reynolds #).

$$\text{VPBAR} = .6 \cdot (a - [\text{HBAR}]) \quad (20)$$

- MBAR--average cruise Mach number.

$$\text{MBAR} = \frac{(\text{MN} - \text{CR1}) + (\text{MN} - \text{CR2})}{2} \quad (21)$$

- KBAR--average cruise kinematic viscosity.

$$\text{KBAR} = \frac{(\nu - \text{CR1}) + (\nu - \text{CR2})}{2} \quad (22)$$

- RNFT--Reynolds number per foot for average cruise conditions.

$$\text{RNFT} = \frac{\text{Min}(\text{VBAR}, \text{VPBAR})}{\text{KBAR}} \quad (23)$$

- L--airfoil maximum thickness location factor.

L = 1.6 assumed

L = 1.2 for max (T-C) @ $x > .3C$

L = 2.0 for max (T-C) @ $x > .3C$

(24)

- R--airfoil lifting surface correlation factor.

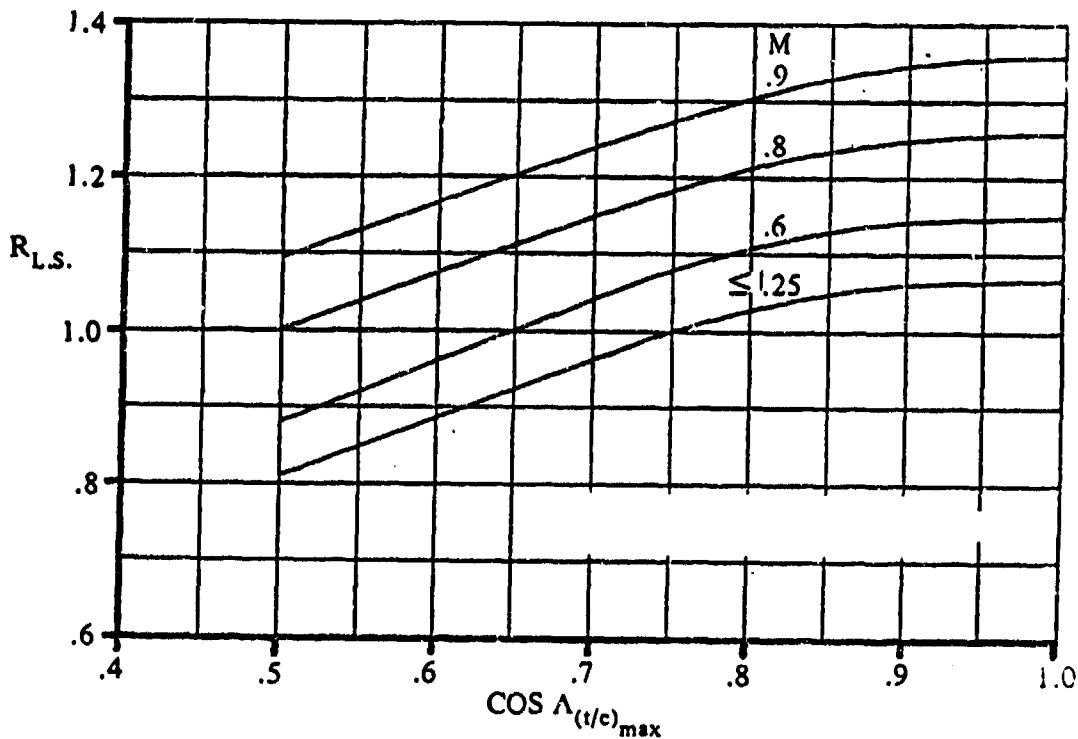

Source: Reference 3.

$$\begin{aligned}
 R &= .75 \cos(\text{SWEEP}) + .4375 + .6864 \cdot (\text{MBAR} - .25)^2 & \cos(\text{SWEEP}) < .8 \\
 R &= .28 \cos(\text{SWEEP}) + .79 + .6864 \cdot (\text{MBAR} - .25)^2 & \cos(\text{SWEEP}) > .8
 \end{aligned}
 \tag{25}$$

The lift curve slopes are determined for the M=0 and the high speed (DS1, DS2) cases.

- [xx]CLAOA-[xxx]--W/HS lift curve slopes.

$$[xx] \text{ CLAOA} - [xxx] = \frac{2 \cdot \pi \cdot AR}{2 + \sqrt{4 + AR^2 (B - [xxx])^2 + \tan^2(\text{SWEEP})}}
 \tag{26}$$

- HSWB/FL--horizontal stabilizer to wing-body aerodynamic center distance divided by fuselage length.

$$\text{HSWB/FL} = |\text{NHS/FL} - \text{NWB/FL}|
 \tag{27}$$

- NLG/FL--nose to landing gear distance divided by fuselage length.

$$NLG/FL = NCG/FL + \frac{WMAC}{10 \cdot FL} \text{ conventional}$$

$$NLG/FL = NWB/FL + \frac{WMAC}{10 \cdot FL} \text{ canard} \quad (28)$$

- CGLG/FL--center of gravity to landing gear distance divided by fuselage length.

$$CGLG/FL = NLG/FL - NCG/FL \quad (29)$$

- WBCG/FL--wing-body aerodynamic center to center of gravity distance divided by fuselage length.

$$WBCG/FL = |NWB/FL - NCG/FL| \quad (30)$$

- HSLG/FL--horizontal stabilizer to landing gear distance divided by fuselage length.

$$HSLG/FL = |NLG/FL - NHS/FL| \quad (31)$$

- WBLG/FL--wing-body aerodynamic center to landing gear distance divided by fuselage length.

$$WBLG/FL = NLG/FL - NWB/FL \quad (32)$$

- SVS--vertical stabilizer area.

$$SVS = \frac{VSVC \cdot SPAN \cdot SW}{[NVS/FL - NWB/FL] \cdot FL} \quad (33)$$

The horizontal stabilizer, either a canard or a conventional tail, is sized using two criterion: take-off rotation and stability.

- CANVOLCO--canard volume coefficient-stability criteria.

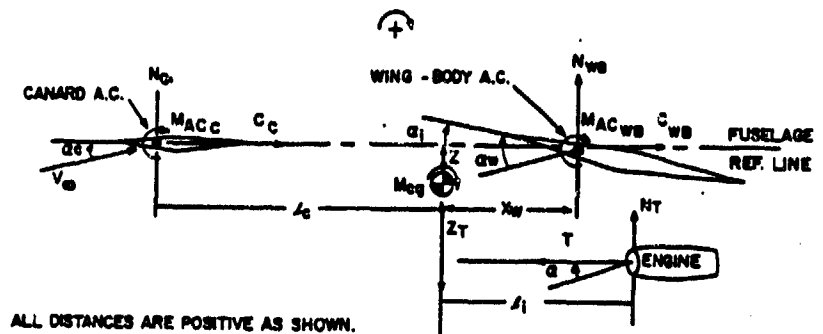

ALL DISTANCES ARE POSITIVE AS SHOWN.
 FOR SMALL α ONE MAY ASSUME:
 $N = \text{NORMAL FORCE} = L = C_n q S_w$
 $C = \text{CHORD FORCE} = D = C_d q S_w$

$$V_c = \text{CANARD VOLUME COEFF} = \frac{L_c S_c}{S_w}$$

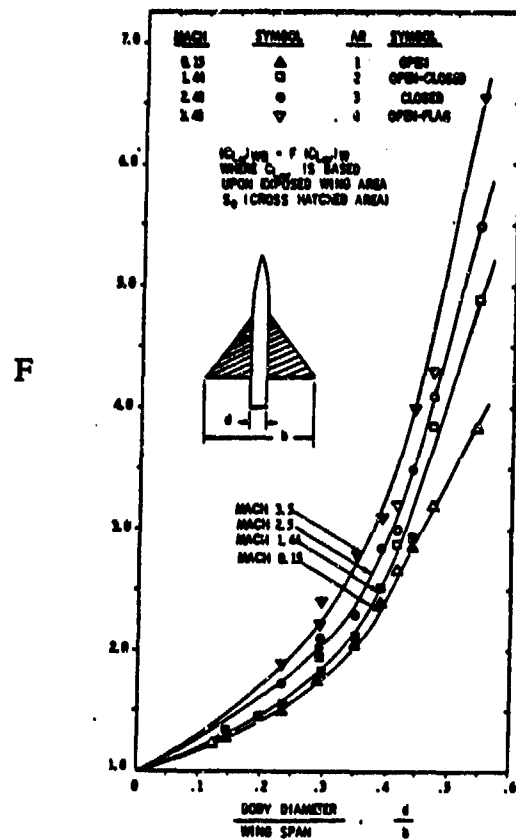

From:

$$\frac{dc_{m\infty}}{d\alpha} = c_{M\infty} = \text{CANVOLCO} \cdot ([HS] \text{ CLAOA}) - \frac{X_W}{SMAC} \cdot ([W] \text{ CLAOA}) - SM \cdot ([WB] \text{ CLAOA}) \quad \text{and}$$

$$F = 2 \frac{FD}{SPAN} + 1 \quad \text{for small } \frac{FD}{SPAN}$$

$$\text{CANVOLCO} = \frac{-SM \cdot [W] \text{ CLAOA} \cdot \left(2 \frac{FD}{SPAN} + 1 \right) + \frac{(WBCG/FL.FL)}{WMAC} \cdot ([W] \text{ CLAOA})}{[HS] \text{ CLAOA}} \quad (34)$$

- CDA1--canard area-stability criteria.

$$\text{CDA1} = \frac{\text{CANVOLCO} \cdot WMAC \cdot SW}{FL \cdot (HSWB/FL - WBCG/FL)} \quad (35)$$

- CDA2--canard area-takeoff rotation criteria.

TO-ROTATION SIZING

Canard Configuration:

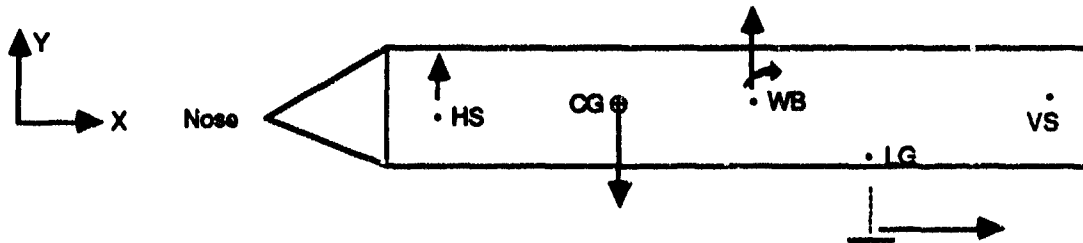

$$+\uparrow \Sigma M_{LG} = 0$$

$$\begin{aligned} & \text{MU-R (TOGW - CL-Min} \cdot \text{Q-TO} \cdot \text{SW}) \cdot \text{Y}_{LG} \\ & - \text{CMOF} \cdot \text{Q-TO} \cdot \text{SW} \cdot \text{CMAC} \\ & + \text{TOGW} \cdot |X_{CG} - X_{LG}| \\ & - \text{CL-Min} \cdot \text{Q-TO} \cdot \text{SW} \cdot |X_{WB} - X_{LG}| \\ & - \text{CL-Max(HS)} \cdot \text{Q-TO} \cdot |X_{HS} - X_{LG}| \cdot \text{SHS} = 0. \end{aligned}$$

$$\text{CDA2} = \left[\text{MUR} \begin{pmatrix} \text{TOGW} \cdot (\text{CL-MinF}) \cdot (\text{Q-TO}) \cdot \text{SW} \cdot 5 \\ - \text{CMOF} \cdot (\text{Q-TO}) \cdot \text{SW} \cdot \text{WMAC} \\ + \text{TOGW} \cdot (\text{CGLG/FL} \cdot \text{FL}) \\ - (\text{CL-MinF}) \cdot (\text{Q-TO}) \cdot \text{SW} \cdot \text{WBLG/FL} \cdot \text{FL} \\ \text{HSLG/FL} \cdot \text{FL} \cdot (\text{Q-TO}) \cdot (\text{CL-MAXF}) \end{pmatrix} \right] \quad (36)$$

- CANAREA--required canard area.

$$\text{CANAREA} = \text{Max}(\text{CDA2}, \text{CDA1}) \quad (37)$$

- COEFF-KA--tail downwash ratio coefficient KA.

$$\text{KA} = \frac{1}{\text{AR}} - \frac{1}{1 + \text{AR}^{1.7}} \quad (38)$$

- COEFF-KLAM--tail downwash ratio coefficient KLAMDA.

$$\text{K}\lambda = \frac{(10 - 3 \cdot \lambda)}{7} \quad (39)$$

- COEFF-KH--tail downwash ratio coefficient KH.

$$KH = \frac{1 - \frac{HSOD}{SPAN}}{\sqrt[3]{\frac{2 \cdot HSWB/FL \cdot FL}{SPAN}}} \quad (40)$$

- DEP/DAOA--horizontal tail downwash ratio (gradient).

$$DEP/DAOA = \frac{d\epsilon}{d\alpha} = 4.44 \cdot [KA \cdot K\lambda \cdot KH \sqrt{\cos(SWEEP)}]^{1.19} \quad (41)$$

Source: Reference 4.

- CONVOLCO--conventional horizontal tail volume coefficient.

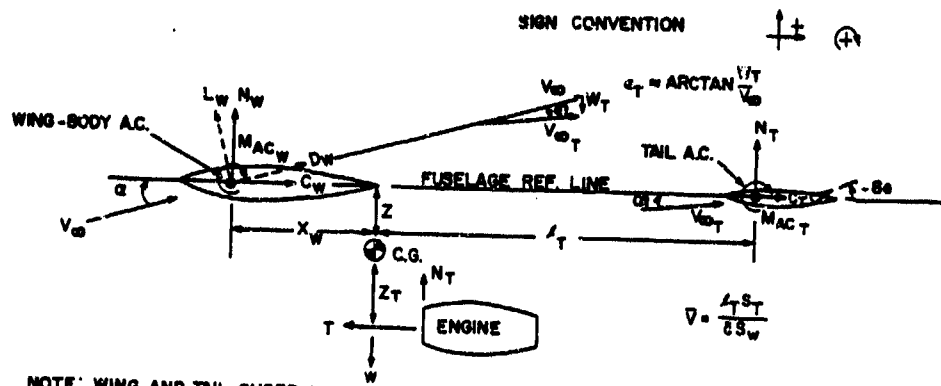

NOTE: WING AND TAIL CHORD LINES ARE PARALLEL TO FUSELAGE REFERENCE LINE.
 ALL DISTANCES ARE POSITIVE AS SHOWN.
 α_T = TAIL DOWNWASH ANGLE DUE TO WING DOWNWASH w_T AT THE TAIL A.C.
 FOR SMALL α WE CAN ASSUME:
 N = NORMAL FORCE = $L = C_L q S_w$
 C = CHORD FORCE = $D = C_D q S_w$

From:

$$\frac{dC_{Mcg}}{d\alpha} = C_{Mcg} = ([W] \text{ CLAOA}) \cdot \frac{X_w}{WMAC} - ([HS] \text{ CLAOA}) \cdot \left(1 - \frac{d\epsilon}{d\alpha}\right) \cdot \text{Convolve} \cdot l_T$$

$$\text{CONVOLCO} = \frac{\left[-SM \cdot \left(\frac{[W] \text{ CLAOA} \cdot \left(2 \frac{FD}{SPAN} + 1 \right)}{WMAC} + \frac{WBCG/FL \cdot FL}{WMAC} [W] \text{ CLAOA} \right) \right]}{[HS] \text{ CLAOA} \cdot 95 \left(1 - \frac{d\epsilon}{d\alpha} \right)} \quad (42)$$

- CVA1--conventional tail area-stability criteria.

$$\text{CVA1} = \frac{\text{CONVOLCO} \cdot WMAC \cdot SW}{(HSWB/FL - WBCG/FL) \cdot FL} \quad (43)$$

- CVA2--conventional tail area-takeoff rotation criteria.

TO-ROTATION SIZING

Conventional Configuration:

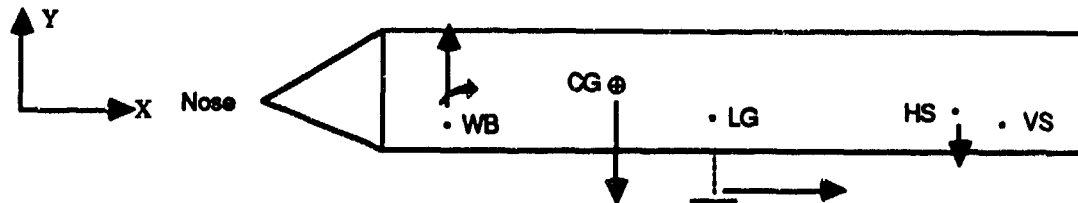

$$+\uparrow \Sigma M_{LG} = 0$$

$$\text{MU-R (TOGW - CL-Min} \cdot \text{Q-TO} \cdot \text{SW}) \cdot Y_{LG}$$

$$- \text{CMOF} \cdot \text{Q-TO} \cdot \text{SW} \cdot \text{CMAC}$$

$$+ \text{TOGW} \cdot |X_{CG} - X_{LG}|$$

$$- \text{CL-Min} \cdot \text{Q-TO} \cdot \text{SW} \cdot |X_{WB} - X_{LG}|$$

$$- \text{CL-Max(HS)} \cdot \text{Q-TO} \cdot |X_{HS} - X_{LG}| \cdot \text{SHS} = 0.$$

$$CVA2 = \frac{\left[\begin{array}{l} MU \cdot R \cdot (TOGW - (CL - MinF) \cdot (Q - TO) \cdot SW) \cdot 5 \\ - CMOF \cdot (Q - TO) \cdot SW \cdot WMAC \\ + TOGW \cdot CGLG / FL \cdot FL \\ - (CL - MinF) \cdot (Q - TO) \cdot SW \cdot WBLG / FL \cdot FL \end{array} \right]}{(HSLG / FL \cdot FL) \cdot (Q - TO) \cdot (CL - MAXF)} \quad (44)$$

- CONVTAREA--required conventional tail area.

$$CONVTAREA = \text{Max} (CVA1, CVA2) \quad (45)$$

- SHS--horizontal stabilizer area.

$$\text{Control input determines whether } SHS = CONAREA \text{ or } SHS = CONVTAREA \quad (46)$$

The clean aircraft zero-lift drag coefficient is found using the component build-up method. This method involves the summation of the equivalent flat plate drag (f) of each component of the aircraft multiplied by a factor to account for interference effects. The components are the wing, fuselage, and horizontal and vertical stabilizer. The interference is usually +/- 5 percent of the value obtained.

The procedure for this method is outlined below.

- LTH-[xx]--component representative length (feet).

$$LTH - [W] = WMAC$$

$$LTH - [F] = \text{Fuselage length, FL}$$

$$LTH - [HS], [VS] = \text{Mean Aerodynamic chord length.} \quad (47)$$

- WA-[xx]--component wetted area.

$$WA - [W] = 2.1 \left(1 - \frac{2FD}{SPAN \cdot (1 + \lambda)} \right)$$

$$WA - [F] = FWA \cdot \Pi \cdot FD \cdot FL$$

$$WA - [HS], [VS] = 2.0 \cdot SHS, SVS \quad (48)$$

- RE#[xx]--component Reynolds number.

$$RE\# - [xx] = RNTF \cdot (LTH - [xx]) \quad (49)$$

- CRE#[xx]--component cutoff Reynolds number.

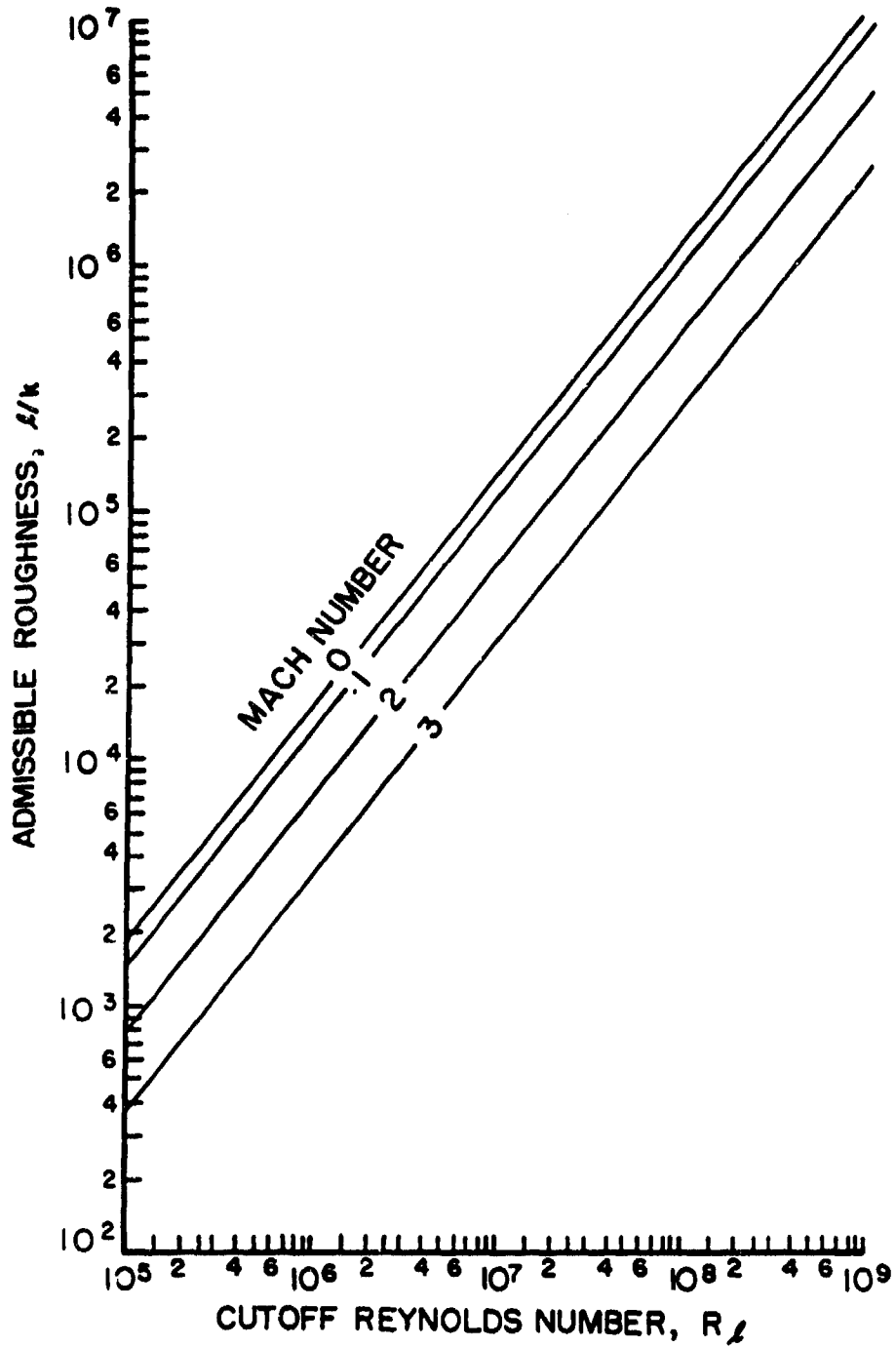

$$CRE\#[xx] = 10^{\left(\frac{\left(\frac{\text{Log} \left(\frac{LTH\#[xx]}{12} \right) + 1.617}{ESR} \right)}{.9575} \right)}$$

(50)

CF-[xx]--component skin friction coefficient

Turbulent flow assumed for all aircraft components.

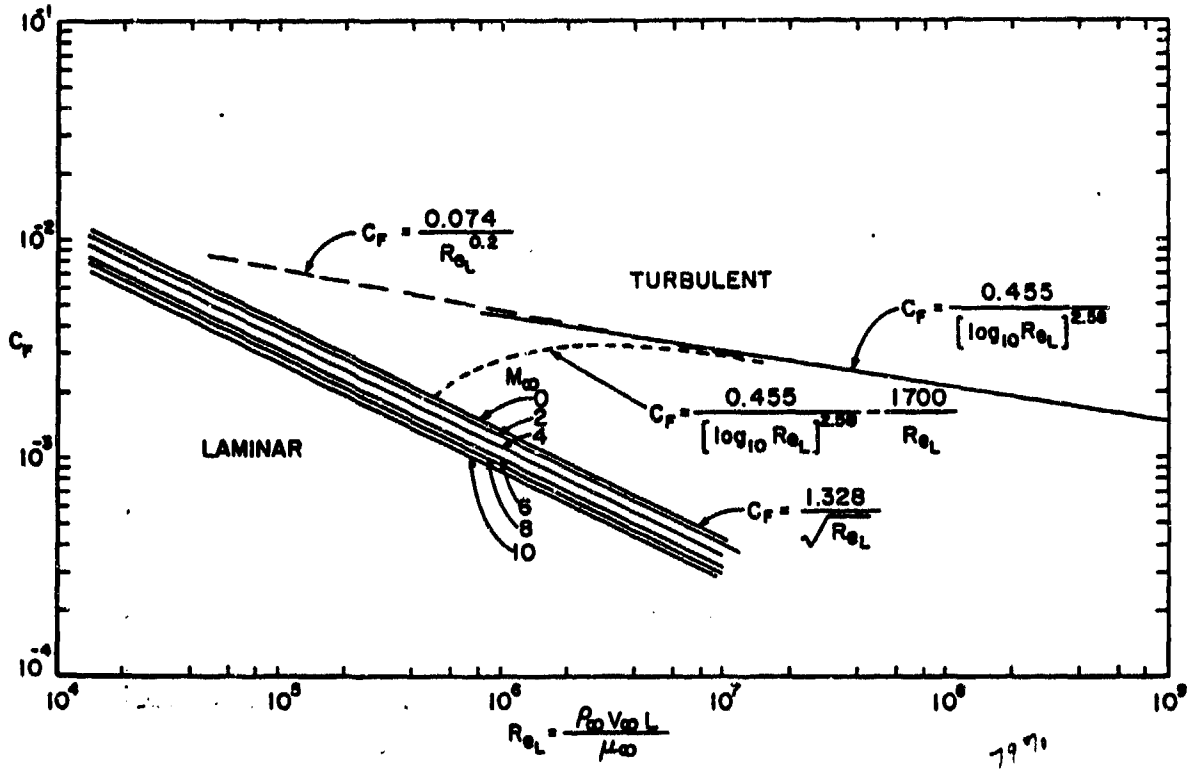

$$CF - [xx] = \frac{.455}{\left[\log_{10} \left(\text{Min} [RE\#, CRE\#] \right) \right]^{2.58}} \cdot \left(1 + .144 \text{MBAR}^2 \right)^{.65} \quad (51)$$

- F-[xx]--component equivalent flat plate drag.

$$F-[F] = (CF-F) \cdot (WA-F) \cdot \left(1 + \frac{60}{\left(\frac{FL}{FD}\right)^3} + .0025 \cdot \left(\frac{FL}{FD}\right) \right)$$

$$F-[W] = (CF-W) \cdot (WA-W) \cdot \left(1 + L \cdot (T-C) + 100 \cdot (T-C)^4 \right)$$

$$F-[HS], [VS] \text{ Similar to Wing.} \quad (52)$$

- CD0--clean aircraft zero-lift drag coefficient.

$$CD0 = (\text{Interference Factor}) \cdot \frac{(F-F + F-W + F-VS + F-HS + F-M)}{SW} \quad (53)$$

- CD0[xxx]--phase CD0s.

$$CD0[xxx] = CD0 + \frac{DF-[xxx]}{SW} \quad (54)$$

- CLOPT[xxx]--phase optimum lift coefficients.

$$CLOPT [xxx] = \sqrt{\frac{CD0[xxx] + KPP \cdot (CL-MIN)^2}{KP + KPP}} \quad (55)$$

- LODMAX[xxx]--phase optimum lift/drag.

$$\frac{1}{\sqrt{\left[CD0[xxx] + KPP \cdot (CL-MIN)^2 \right] \cdot (KP + KPP) - 2 \cdot KPP \cdot (CL-MIN)}} \quad (56)$$

- ASTAR--coefficient for transonic drag rise.

$$ASTAR = AR \cdot (T-C)^{1/3} \quad (57)$$

- MSTAR[xxx]--phase coefficients for transonic drag rise.

$$MSTAR [xxx] = \frac{\sqrt{|(MN-[xxx])^2 - 1|}}{(T-C)^{1/3}} \quad (58)$$

- CDW-[xxx]--phase transonic wing wave drag coefficients.

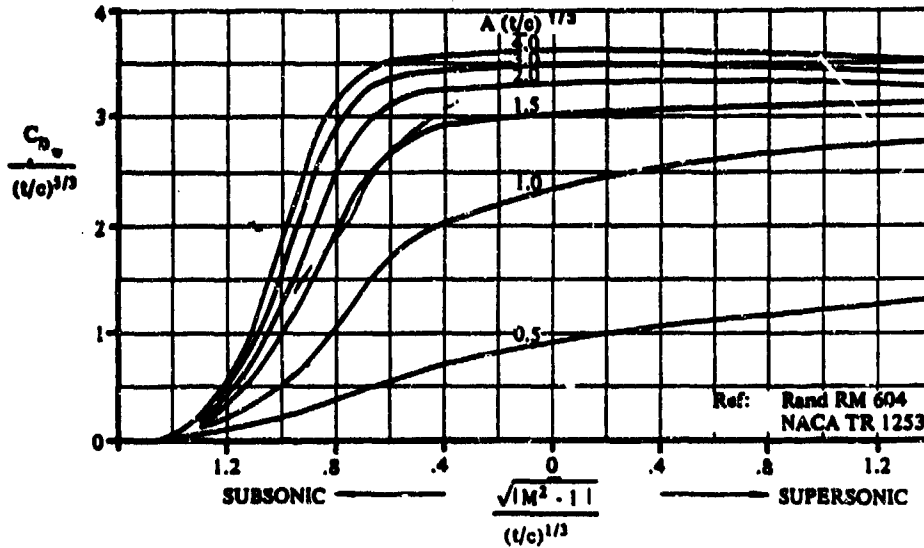

CDW = Table lookup with ASTAR and MSTAR.

$$CDSTAR = \frac{CDW}{(T-C)^{5/3}} \quad (59)$$

- POTF-[xxx]--phase percent of time factors.

$$POTF-[xxx] = 1 - \sum_{[TO]}^{[xxx]} \% \text{ MSN Time} \quad (60)$$

Ten minutes assumed for taxi, warm-ups, etc.

- WOS-[xxx]--phase wing loadings.

$$WOS[xxx] = \frac{OWE + (TOGW - OWE - (PL - TO) - (PL - LD)) \cdot (POTF-[xxx]) + PL-[xxx]}{SW} \quad (61)$$

- V-LT[#]--loiter velocities.

$$V-LT[\#] = \sqrt{\frac{2 \cdot WOS-LT[\#] \cdot 1.689}{\rho-LT[\#] \cdot CLOPT-LT[\#]}} \quad (62)$$

- Q-LT[#]--loiter dynamic pressures.

$$Q-LT[\#] = \frac{(\rho-LT[\#]) \cdot (V-LT[\#])^2}{2} \quad (63)$$

- MN-LT[#]--loiter Mach numbers.

$$MN-LT[\#] = \frac{V-LT[\#]}{a-LT[\#]} \quad (64)$$

- B-LT[#]--loiter betas.

$$B-LT[x] = \sqrt{|(MN-LT[x])^2 - 1|} \quad (65)$$

- LDFCTR1--load factor for turns at V-CB.

$$LDFCTR1 = \sqrt{\left(\frac{TR \cdot (V-CB)}{g \cdot \Pi \cdot 1.689}\right)^2 + 1} \quad (66)$$

- CL-[xxx]--phase required lift coefficients.

$$CL-[xxx] = \frac{WOS-[xxx]}{Q-[xxx]} \quad (67)$$

- CD-[xxx]--phase resultant drag coefficients.

$$CD[xxx] = CDW-[xxx] + CDO[xxx] + KP \cdot (CL-[xxx])^2 + KPP \cdot [(CL-[xxx]) - (CL-Min)]^2 \quad (68)$$

- TREQ-[xxx]--phase thrust required (drag levels).

$$TREQ-[xxx] = (CD-[xxx]) \cdot (Q-[xxx]) \cdot SW \quad (69)$$

- LOD-[xxx]--phase lift/drag levels.

$$LOD-[xxx] = \frac{CL-[xxx]}{CD-[xxx]} \quad (70)$$

- T/W-TOR[xxx]--phase takeoff thrust loading required.

$$T/W-TOR[xxx] = \frac{TREQ-[xxx]}{TOGW \cdot [1 + (MN-[xxx]) \cdot LRMS]} \cdot \frac{TALT[##]}{ALT[##]} \quad (71)$$

- T/W-TO--thrust loading required at takeoff.

$$T/W-TOR = \text{Max}(T/W-TOR[xxx]) \quad (72)$$

- TAVL-[xxx]--phase thrust available levels.

$$TAVL-[xxx] = T/W-TOR \cdot TOGW \cdot [1 + (MN-[xxx]) \cdot LRMS] \cdot \frac{TALT[##]}{ALT[##]} \quad (73)$$

Fuel Calculations:

- PWR-[xxx]--phase percents of full power.

$$PWR-[xxx] = \frac{TREQ-[xxx]}{TAVL-[xxx]} \quad (74)$$

The results of SFC vs. altitude interpolation for the phases are tabulated here.

- SFC-[xxx]--phase specific fuel consumption.

SFC's interpolated from input data given PWR-[xxx], H-[xxx], and MN-[xxx] (75)

- RF-[xxx]--phase range factors (where applicable).

$$RF - [xxx] = \frac{(LOD - [xxx]) \cdot (V - [xxx])}{(SFC - [xxx])} \quad (76)$$

- EF-[xxx]--phase endurance factors (where applicable).

$$EF - [xxx] = \frac{LOD - [xxx]}{SFC - [xxx]} \quad (77)$$

- W#W#--phase fuel fractions.

$$W\#W\# = \frac{1}{e^{(x-[xxx])/RF-[xxx]})} \text{ or } \frac{1}{e^{(T-[xxx])/EF-[xxx]})} \quad (78)$$

- TOGWR--take-off gross weight required.

$$TOGWR = FCF \cdot \frac{1}{\sum W\#W\#} \cdot OWE + (PL-TO) \quad (79)$$

- FUEL--mission fuel required.

$$FUEL = TOGWR - OWE - (PL-TO) - (PL-LD) \quad (80)$$

Take-off/Landing & Low Speed Maneuverability Calculations:

- RHO-[TO/LD]--takeoff and landing air densities.

$$RHO[TO/LD] = \text{Table lookup with } H = \rho\text{-[TO/LD]} \quad (81)$$

- VS[F/NF]--take-off stall velocities.

$$VS[F/NF] = \sqrt{\frac{(WOS-TO) \cdot 2}{(\rho-TO) \cdot (CL-MAX[F/NF])}} \quad (82)$$

- VTO[F/NF]--take-off velocities.

$$VTO[F/NF] = 1.15 \cdot VS[F/NF] \quad (83)$$

- VS[F/NF]--landing stall velocities.

$$VS[F/NF] = \sqrt{\frac{(WOS-LD) \cdot 2}{(\rho-LD) \cdot (CL-MAX[F/NF])}} \quad (84)$$

- VLD[F/NF]--landing velocities.

$$VLD[F/NF] = 1.15 \cdot VS[F/NF] \quad (85)$$

- WOSTOR--takeoff required wing loading.

$$WOSTOR = \frac{(X-TO) \cdot 3 \cdot VTO[F/NF] \cdot g \cdot (\rho-TO) \cdot (CL-MAX[F/NF]) \cdot (TAVL-TOLD)}{1.15^2 \cdot TOGWR} - (MU-R) \cdot \frac{.5 \cdot (\rho-TO) \cdot (.707 \cdot VTO[F/NF])^2 \cdot SW \cdot CDO[TO]}{TOGWR} \quad (86)$$

- WOSLDR--landing required wing loading.

$$WOSLDR = [(X-LD) \cdot 3 \cdot VTO[F/NF] \cdot g \cdot (\rho-LD)] \cdot \frac{CL-MAX[F/NF]}{(1.15)^2} + \left(MU-B+TRF \cdot \frac{(TAVL-TOLD)}{TOGWR} \right) + \frac{.5 \cdot (\rho-LD) \cdot (.707 \cdot VLD[F/NF])^2 \cdot SW \cdot CDO[LD]}{(WOS-LD) \cdot SWR} \quad (87)$$

- SW[xxx]--takeoff, landing, low speed maneuverability required wing area.

$$\left. \begin{aligned} SW[TOR] &= \frac{TOGWR}{WOSTOR} \\ SW[LDR] &= \frac{OWE+(PL-LD)}{WOSLDR} \\ SW[MANR] &= \frac{(WOS-CB) \cdot SW \cdot NVMINCB}{\frac{1}{2} (\rho-TO) (V-MINCB \cdot 1.689)^2 \cdot (CL-MAX[F/NF])} \end{aligned} \right\} \quad (88)$$

- X-TOR--takeoff distance required.

$$XTOR = (WOS-TO) \cdot (\rho-TO) \cdot \frac{CL-MAX[F/NF]}{1.15^2} \cdot \frac{(TAVL-TOLD)}{TOGWR} - (MU-R) \cdot \frac{.5(\rho-TO) \cdot (.707 \cdot VTO[F/NF])^2 \cdot SW \cdot CDO[TO] + 3 \cdot VTO[F/NF]}{TOGWR} \quad (89)$$

- X-LDR--landing distance required.

$$X-LDR = \frac{(WOS-LD) \cdot (1.15)^2}{g (\rho-LD) \cdot (CL-MAX[F/NF])} \cdot \left[\frac{TOGWR}{(MU-B) + TRF \cdot (TAVL-TOLD)} \right] + \left[\frac{.5 (\rho-LD) \cdot (.707 \cdot VLD[F/NF])^2 \cdot SW \cdot CDOLD}{(WOS-LD) \cdot SWR} \right] + 3 \cdot VLD[F/NF] \quad (90)$$

Empty Weight Calculations:

This section of the FSM detailed output contains the aircraft empty weight (OWE) calculations. The equations used are from various sources. They encompass four distinct categories:

- Structure
- Propulsion
- Survivability (armor)
- Miscellaneous.

The weight of each category is then summed to yield the empty weight of the aircraft.

B. RANGE-PAYLOAD MODEL

The methodology for RPM is very similar to that of the sizing model described previously. The flowcharts for RPM and FSM are shown in Chapter 3. However, while the equations used in the two models are the same, the aim of each is quite different.

One of the main differences is that in RPM the emphasis is to determine the mission radius, given the required inputs and the amount of fuel. In the sizing model, the fuel required is obtained. Another difference between the two models is that in the range-payload model, there is no empty weight calculation section. This is because this model uses the fixed aircraft configuration and empty weight that was sized in FSM.

C. ENERGY/MANEUVERABILITY MODEL

The methodology for the energy/maneuverability model is described in this section. Again, the outline for this is shown in the respective flowchart in Chapter 3. The detail output uses the same equations and methods as in the other models except that the values are calculated for the velocity spectrum (CB1-CB12) rather than the mission phases ([xxx]). In addition, the ABX factor allows for the use of increased thrust in the maneuverability analyses, while in the other two models, the use of increased thrust over maximum was restricted to takeoff.

However, there are many new parameters generated in the table in the summary output. Thus, additional equations were required for this section. The following outlines the process used for determining these values.

- NS--maximum sustained load factor.

$$NS = \text{Min} \left\{ \begin{array}{l} \frac{NL}{(CL-MAX)} \cdot \frac{Q-CB(x)}{WOS-CB} \\ \frac{Q-CB(x)}{WOS-CB} \cdot \sqrt{\frac{TAVL-CB(x) - CDO[CB] + CDW-[CD]}{Q-CB(x)} \cdot SW} \end{array} \right\} \quad (91)$$

- Sustained Turn Rate.

$$TR_S = \frac{\sqrt{N_S^2 - 1} \cdot g \cdot 180}{(V-CB(x)) \cdot \Pi} \quad (92)$$

- Sustained Turn Radius.

$$R_S = \frac{(V-CB(x))^2}{g \cdot \sqrt{N_S^2 - 1}} \quad (93)$$

- N Instantaneous--maximum instantaneous load factor.

$$N_I = \text{Min} \left\{ \frac{NL}{CL-MAX} \cdot \frac{(Q-CB(x))}{(WOS-CB)} \right\} \quad (94)$$

- Instantaneous Turn Rate.

$$TR_I = \frac{\sqrt{N_I^2 - 1} \cdot g \cdot 180}{(V-CB(x)) \cdot \Pi} \quad (95)$$

- Instantaneous Turn Radius.

$$R_I = \frac{(V-CB(x))^2}{g \cdot \sqrt{N_I^2 - 1}} \quad (96)$$

- Ps @ 1 G--specific power at 1G.

$$P_S = \frac{(V-CB(x)) \cdot [(TAVL-CB(x)) - (TREQ-CB(x))]}{(WOS-CB) \cdot SW} \quad (97)$$

- Maximum R/C--maximum rate of climb (fpm).

$$R/C_{MAX} = P_S \cdot 60 \quad (98)$$

- Maximum Climb Angle.

$$\delta_{\text{Max}} = \frac{(\text{TAVL-CB}(x)) - (\text{TREQ-CB}(x))}{\text{TOGW} \cdot \left(\frac{180}{\Pi}\right)} \quad (99)$$

- V-MAX--maximum velocity.

Interpolation for maximum velocity given PWR (% power) at each CB velocity.

- V-MIN--minimum velocity.

$$\text{V-MIN} = \sqrt{\frac{2 \cdot \text{TOGW}}{(\text{RHO}-[\text{CB}] \cdot \text{SW} \cdot (\text{CL-MAX}))}} \quad (100)$$

- V-L/D MAX--velocity for maximum lift/drag.

$$\text{V} \cdot \frac{\text{L}}{\text{D}} \text{Max} = \sqrt{\frac{2 \cdot (\text{WOS-CB})}{(\text{RHO}-[\text{CB}]) \cdot (\text{CLOPT}-[\text{CB}])}} \quad (101)$$

D. COST ESTIMATION MODEL

The methodology from reference 17 was used exclusively for this model. The following are the equations used for determining the DCPR weight and the CERs. All costs are in millions of FY85 dollars.

- DCPR -- Defense Contractors Planning Report Weight.

$$\text{DCPR} = \left\{ \begin{array}{l} .0913 (\text{OWE})^{1.177} \text{ for OWE} > 50,000 \\ .246 (\text{OWE})^{1.096} \text{ for } 10,00 \leq \text{OWE} \leq 50,000 \\ 13.26 (\text{OWE})^{.674} \text{ for OWE} < 10,000 \end{array} \right\} \quad (102)$$

- RDTE -- Research Development Test and Evaluation Cost.

$$\text{RDTE} = 2.18 (10)^{-6} \cdot (\text{DCPR})^{2.0493} \cdot \left(\frac{\text{T-MAX}}{\text{DCPR}}\right)^{1.7} \cdot (1.0239)^{\text{IOC-78}} \quad (103)$$

- FLY -- Flyaway Cost.

$$\text{FLY} = .194 \left(\frac{\text{DCPR}}{1000}\right)^{.963} \cdot \left(\frac{\text{V-MAX}}{100}\right)^{.760} \cdot (1.034)^{\text{IOC-78}} \quad (104)$$

- PROC -- Procurement Cost.

$$\text{PROC} = \text{FLY} \cdot \left\{ \begin{array}{l} 2.12 (\text{Air Force}) \\ 1.88 (\text{Navy/Marines}) \\ 1.652 (\text{Army}) \end{array} \right\} \quad (105)$$

APPENDIX C

List of Available Macros

<u>Command</u>	<u>Purpose</u>	<u>Models</u>
ALTR	Run model Initiate Run Menu	FSM, RPM, CEM, EMM
ALTP	Initiate Print Menu	FSM, RPM, EMM, CEM
ALTT	Transfer Variable Data	RPM, EMM
ALTG	Initiate Graph Menu	EMM